

**Version
as at 1 April 2024**



Fisheries (Commercial Fishing) Regulations 2001

(SR 2001/253)

Silvia Cartwright, Governor-General

Order in Council

At Wellington this 17th day of September 2001

Present:

Her Excellency the Governor-General in Council

Pursuant to section 297 of the Fisheries Act 1996, Her Excellency the Governor-General, acting on the advice and with the consent of the Executive Council, makes the following regulations.

Contents

	Page
1 Title	7
2 Commencement	7
3 Interpretation	7
4 Certain other regulations prevail over these regulations	17

Note

The Parliamentary Counsel Office has made editorial and format changes to this version using the powers under subpart 2 of Part 3 of the Legislation Act 2019.

Note 4 at the end of this version provides a list of the amendments included in it.

These regulations are administered by the Ministry for Primary Industries.

Part 1
New Zealand fishing vessels and foreign-owned New Zealand fishing vessels

Administrative matters

5	Change of name of vessel	17
6	Changes of information must be notified	17
7	Certificate of registration, certificate of notification, and fishing permits must be produced	17
8	Alteration and replacement of certificate of registration, certificate of notification, or fishing permit	18

Marking of vessels

9	Name of vessel	18
10	Marking of vessels with registration number	18
11	Marking of vessels with international call sign	19
12	Colour of letters and figures	19
13	Letters and figures must be maintained	19
14	Display of false or misleading letters or figures	19
15	Alternative position for marking vessels	20
16	Marking of tenders	20

Part 2

Conditions applying to foreign-owned New Zealand fishing vessels and registered fish carriers

Conditions of general application to certificates of registration

17	Reporting obligations	21
18	Carriage and transfer of fishing equipment	22
19	Transshipment of fish	22
20	Communications	23
21	Boarding procedures	24
22	Helicopter transfer	25
23	Facilities for observers	25

Additional conditions applying to particular types of fishing vessels: Tuna longline fishing

24	Areas closed to longliners	25
25	Tagging of billfish caught by tuna longliners	25
26	Application for approval for southern bluefin tuna longlining [Revoked]	26

Skipjack tuna purse seiners

27	Conditions applying to skipjack tuna purse seiners	26
28	Returns required in relation to skipjack tuna purse seining	26

Squid jiggers

29	Conditions applying to squid jiggers	27
----	--------------------------------------	----

Part 3
Restrictions on commercial fishing for certain species

Marlin

30	Restrictions on taking marlin	27
----	-------------------------------	----

Finfish

31	Minimum finfish length and net mesh size	27
----	--	----

Shellfish

32	Size limits on shellfish	29
33	Restrictions on opening shellfish	29
34	Restrictions on taking oysters	30
35	Restrictions on taking and possessing scallops	30
36	Taking and possessing toheroa prohibited	30

Rock lobster

37	Size limit on rock lobster	30
38	Method of measurement of rock lobster tail	31
39	Instruments used for measuring rock lobster	32
40	Method of measurement of packhorse rock lobster <i>[Revoked]</i>	32
41	Taking, possessing, processing, and sale of certain rock lobsters prohibited	33
42	Rock lobsters must be landed and processed alive	33

Salmon

43	Taking or possession of salmon prohibited	34
----	---	----

Black coral

44	Taking and possession of black coral prohibited	34
----	---	----

Marine turtles

45	Taking and possession of marine turtles prohibited	34
46	Uninjured turtles must be immediately returned to waters from which taken	35
47	Injured turtles	35
48	Circulars relating to marine turtles	35
49	Turtle catches must be reported <i>[Revoked]</i>	36

Eels

50	Maximum legal weight for eels taken from New Zealand fisheries waters	36
51	Minimum weight for eels taken from New Zealand fisheries waters	36
52	Use of fyke nets to take eels in South Island fisheries waters <i>[Revoked]</i>	36

Brown bullhead catfish

52A	Sale of live brown bullhead catfish prohibited	36
-----	--	----

	<i>Shark finning</i>	
52B	Shark finning prohibited	36
52C	Circulars relating to shark finning	37
	Part 3A	
	Fishing-related mortality limit of Hector's and Māui Dolphin in defined area	
	<i>[Revoked]</i>	
52D	Māui Dolphin habitat zone <i>[Revoked]</i>	38
52E	Fishing-related mortality limit for Hector's or Māui Dolphin within Māui Dolphin habitat zone <i>[Revoked]</i>	38
	Part 4	
	Conditions, restrictions, and prohibitions relating to fishing equipment	
	<i>Labelling of fish containers</i>	
53	Labelling of containers	38
	<i>Marking of fishing gear</i>	
54	Longlines, static fishing gear, and set nets	39
55	Fyke nets	40
56	Pots	40
57	Gear not associated with vessel must be marked	40
	<i>Seabird scaring devices</i>	
58	Seabird scaring devices required for tuna longlining	41
	<i>Avoidance or mitigation of fishing-related seabird mortality</i>	
58A	Circulars may authorise or require seabird mitigation measures	41
58B	Responsibility for compliance	42
	<i>Avoidance or mitigation of fishing-related sea lion mortality</i>	
58C	Sea lion exclusion devices for commercial fishing in quota management area SQU6T	42
58CA	Circular may authorise specifications for sea lion exclusion devices	43
58C	Responsibilities of vessel operator or master in relation to seabird scaring devices <i>[Revoked]</i>	43
	<i>General provisions relating to nets</i>	
58D	Use of drift nets prohibited	43
59	Measurement of net mesh size	44
60	Restrictions on nets in channels	44
61	Stalling prohibited	45
62	Use of poles or stakes	45
63	Use of specified nets prohibited	45
64	Use of net-sonde monitor cables prohibited	45

	<i>Set nets</i>	
65	Length of set net	45
66	Set net soak time	46
	<i>Drag nets and beach seine nets</i>	
67	Length of drag net or beach seine net	46
68	Method of hauling drag net or beach seine net	46
	<i>Danish seine nets</i>	
69	Danish seine net restrictions	47
70	Danish seining prohibited near South Island coast	47
	<i>Trawl nets</i>	
71	Trawl net restrictions	47
71A	Approval of trawl nets	48
71B	Consideration of application for approval	50
71C	Notices relating to approval of trawl net	50
72	Trawling by vessels over 46 m long prohibited in territorial sea	51
73	Trawling prohibited in closed seamount areas	51
74	Other methods of fishing prohibited [<i>Revoked</i>]	52
	<i>Fyke nets</i>	
75	Tubes must be incorporated in fyke nets	52
	<i>Underwater breathing apparatus</i>	
76	Restrictions relating to underwater breathing apparatus	52
76A	Underwater breathing apparatus allowed when taking certain species	52
77	Underwater breathing apparatus allowed in certain circumstances	53
	<i>Shellfish dredges</i>	
78	Shellfish dredge design and size	54
	<i>Pots</i>	
79	Apertures required in rock lobster pots	54
79A	Requirements for pots used for taking blue cod or octopus	55
	<i>Spears</i>	
80	Use of spears prohibited	56
	<i>Wire traces and shark lines</i>	
80A	Use of wire traces and shark lines by commercial tuna and billfish fishers prohibited	56
	<i>Surface longlining hooks</i>	
80B	Use of circular or oval hooks required when surface longlining	56
80C	Circulars relating to surface longlining hooks	57

Part 5
Authorised stocks

[Revoked]

81	Declaration of authorised stocks <i>[Revoked]</i>	57
----	---	----

Part 5A

Alternative methods of disposal

81A	Chief executive may approve alternative method of disposal	58
81B	Use of alternative method of disposal	58
81C	Chief executive may approve use of alternative method of disposal	58
81D	Circulars in relation to alternative methods of disposal	59
81E	Chief executive to review approval of alternative method of disposal	59

Part 6

Fees, offences, and penalties

Fees

82	Fees	60
83	Chief executive may waive or remit certain fees	60

Offences

84	Offences	60
----	----------	----

Penalties

85	Penalties	61
----	-----------	----

Revocation

86	Revocation	62
----	------------	----

Schedule 1

Diagrams relating to method of measurement of rock lobster

Schedule 2

Fees

Schedule 3

Measurement of net mesh size

Schedule 4

**Provisions relating to marking of New Zealand fishing vessels
and foreign-owned New Zealand fishing vessels**

Schedule 5

Authorised stocks

[Revoked]

Regulations

1 Title

These regulations are the Fisheries (Commercial Fishing) Regulations 2001.

2 Commencement

- (1) Except as provided for in subclause (2), these regulations come into force on 1 October 2001.
- (2) Part 5 of Schedule 2 comes into force the day after the date these regulations are notified in the *Gazette*.

3 Interpretation

In these regulations, unless the context otherwise requires,—

Act means the Fisheries Act 1996

albacore means a fish of the species *Thunnus alalunga*

anchovy means a fish of the species *Engraulis australis*

artificially attached, in relation to shark fins, means attached to the corresponding body of the shark through some artificial means, for example, the fins are stitched, tied, or stapled to the body of the shark or secured in a bag with the body of the shark

beachcast seaweed, for the purposes of these regulations, means any beachcast seaweed except,—

- (a) in all fishery management areas, beachcast seaweed of the class *Rhodophyceae* (red seaweed); and
- (b) in fishery management areas 3 to 7, beachcast seaweed of the genera *Durvillea* (rimurapa), *Ulva* (sea lettuce), and *Porphyra* (karengo)

billfish means marlin, sailfish, and spearfish

black coral means the coelenterate of the order *Antipatharia*

blue cod means a fish of the species *Parapercis colias*

blue mackerel means a fish of the species *Scomber australasicus*

blue moki means a fish of the species *Latridopsis ciliaris*

blue shark means a shark of the species *Prionace glauca*

box net or **teichi net** means a trap net capable of taking finfish; but does not include a fyke net

brown bullhead catfish (commonly known as catfish) means a fish of the species *Ameiurus nebulosus*

butterfish means a fish of the species *Odax pullus* and *Odax cyanoallix*

certificate of notification means a certificate issued by the chief executive on the approved form under section 104 of the Act

certificate of registration means either—

- (a) a certificate issued by the chief executive on the approved form under section 103 of the Act; or
- (b) a certificate issued by the chief executive on the approved form under section 105 of the Act

channel, river, or stream includes all waters that are contained by natural or artificial banks

cockle means a shellfish of the species *Chione (Austrovenus) stutchburyi*

cod-end means—

- (a) the part of a net that is normally closed during fishing and is capable of holding fish while in the water; and
- (b) includes, in respect of a net—
 - (i) carried on a vessel not exceeding 10 m in overall length, not less than the last 3 m of net:
 - (ii) carried on a vessel 10 m or more but less than 20 m in overall length, not less than the last 5 m of net:
 - (iii) carried on a vessel 20 m or more but less than 30 m in overall length, not less than the last 10 m of net:
 - (iv) carried on a vessel 30 m or more but less than 40 m in overall length, not less than the last 15 m of net:
 - (v) carried on a vessel 40 m or more in overall length, not less than the last 20 m of net

commercial fisher, for the purposes of these regulations, means a person who has a fishing permit issued under section 91 of the Act entitling that person to take a species or class of fish, aquatic life, or seaweed; and includes—

- (a) a person who is engaged in any capacity on a New Zealand fishing vessel or a foreign-owned New Zealand fishing vessel; and
- (b) a person, whether or not on board a fishing vessel, who takes fish, aquatic life, or seaweed for the purposes of sale

Danish seine net means a net or part of a net (including a warp, rope, chain, material, or device used in conjunction with, or attached to, the net) that—

- (a) has a buoyancy system on the top edge; and
- (b) is weighted on the bottom edge; and
- (c) is operated without the use of a horizontal net opening device by surrounding fish and being drawn over the bed of waters, or through waters, to 1 or more vessels

Danish seining means the use of a Danish seine net

deepwater clam means a shellfish of the species *Panopea zelandica*

drag net or **beach seine net** means a net or part of a net (including a warp, rope, chain, material, or device used in conjunction with, or attached to, the net) that—

- (a) has a buoyancy system on the top edge; and
- (b) is weighted on the bottom edge; and
- (c) is operated by surrounding fish and being drawn over the bed of waters, or through waters, to the shore

dredge means a device towed on or over, or capable of being towed on or over, the seabed primarily for the collection of shellfish; and includes a box dredge or ring device

dropline or **dahn line** means a weighted line to which a number of hooks are attached to the bottom portion that is placed vertically for the purposes of taking fish

eel, for the purposes of regulations made under the Act, means freshwater eel

elephant fish means a fish of the species *Callorhynchus milii*

Fisheries Communication Centre means the Communication Centre of the Ministry of Fisheries in Wellington

fishing gear includes a net, line, pot, trap, dredge, apparatus, device, or thing that is used, or is capable of being used, for the purpose of taking fish

fishing method means the way in which fishing gear is used to take fish or any other practice that may reasonably be expected to result in fish being taken

flapper or **flappers** means a panel or panels of netting inserted inside the trawl net or Danish seine net in such a way that it allows fish to pass from the front to the rear of the net but limits their return

flatfishes include the following species:

- (a) *Rhombosolea plebia* (sand flounder, also known as dab, white, diamond, or square flounder):
- (b) *Pelotretis flavilatus* (lemon sole):
- (c) *Peltorhamphus novaezeelandiae* (New Zealand sole):
- (d) *Rhombosolea leporina* (flounder, also known as yellow belly):
- (e) *Colistium guntheri* (brill):
- (f) *Colistium nudipinnis* (turbot):
- (g) *Rhombosolea retiaria* (black flounder):
- (h) *Rhombosolea tapirina* (greenback flounder)

foreign fishing vessel means a foreign fishing vessel licensed under section 84 of the Act

fyke net means a trap net (set with or without leaders or wings) if—

- (a) the trap section has single or multiple throats and is supported by hoops or rings; and
- (b) the leaders or the net are held in position by poles or anchoring devices, or by both poles and anchoring devices

garfish means a fish of the species *Hyporhamphus ihi* (also known as piper)

geospatial position reporting device has the same meaning as in regulation 3 of the Fisheries (Geospatial Position Reporting) Regulations 2017

groper includes fish of the species *Polyprion oxygeneios* and *Polyprion americanus* (formerly known as *Polyprion moeone*)

hinaki means a trap capable of taking eels

jack mackerel means fish of the genera *Trachurus* spp

kahawai means a fish of the species *Arripis trutta*

kina means a shellfish of the species *Evechinus chloroticus* (also known as the sea egg); and includes the shellfish of the species *Centrostephanus rodgersii* (also known as the purple urchin)

kingfish means a fish of the species *Seriola lalandi*

koheru means a fish of the species *Decapterus koheru*

koi means a fish of the species *Cyprinus carpio*

landing report means a report required by regulation 11 of the Fisheries (Reporting) Regulations 2017

length, unless otherwise specified, means,—

- (a) in relation to finfish, the length from the tip of the nose to the posterior end of the middle ray of the tail fin;
- (b) in relation to scallops, the greatest diameter of the shell;
- (c) in relation to paua, the greatest overall length of the shell measured on a plane parallel to the ventral surface of the paua

longline means a line to which a hook or hooks (whether baited or not) are attached

marine turtle means a reptile of the following species:

- (a) *Caretta caretta* (logger head turtle):
- (b) *Chelonia mydas* (green turtle):
- (c) *Eretmochelys imbricata* (hawksbill turtle):
- (d) *Lepidochelys olivacea* (olive ridley or pacific ridley turtle):
- (e) *Dermochelys coriacea* (leatherback or leathery back or luth turtle)

marlin means a fish of the following species:

- (a) *Tetrapturus audax* (striped marlin):

(b) *Makaira nigricans* (blue marlin):

(c) *Makaira indica* (black marlin)

method of strengthening means a method by which a cod-end, and other parts of the net, can be strengthened by attaching ropes lengthwise to prevent stretching or around the circumference to restrict the diameter under the pressure of accumulated catch

mullet includes a fish of the species *Mugil cephalus* (also known as the grey mullet) and *Upeneichthys lineatus* (also known as the goatfish or red mullet); but does not include yellow-eyed mullet

mussel means a shellfish of the following species:

(a) *Perna canaliculus* (green-lipped mussel):

(b) *Mytilus edulis aoteanus* (blue mussel):

(c) *Atrina zelandica* (horse mussel)

naturally attached, in relation to shark fins, means attached to the corresponding body of the shark through some portion of uncut skin

net means a net or part of a net used, or capable of being used, to take fish; but does not include a whitebait net

net mesh size means the size ascertained by measuring the greatest diagonal distance within a mesh when measured—

(a) using a certified gauge provided by a fishery officer that corresponds to the mesh size to be measured; and

(b) in accordance with Part 2 of Schedule 3

net-sonde monitor cable—

(a) means a continuous cable or wire that—

(i) is operated from a winch located on the aft or stern of a fishing vessel; and

(ii) leads directly from the aft or stern of the vessel to an electronic recorder or monitor attached to the headline, headrope, or meshes of a trawl net; but

(b) does not include an acoustically linked net monitor system that is a paravane or a hull-mounted transducer system

New Zealand authorities includes harbour and port authorities, Maritime New Zealand, Ministry of Agriculture and Forestry, New Zealand Customs Service, New Zealand Defence Force, and New Zealand Police

New Zealand fishing vessel, for the purposes of these regulations, means a fishing vessel registered under section 103(3) or section 105 of the Act; but does not include foreign-owned New Zealand fishing vessels registered with consent under section 103(4) of the Act

New Zealand Government aircraft means an aircraft that belongs to the New Zealand Government; and includes an aircraft set aside for, or used by, the New Zealand Defence Force

New Zealand Government ship, for the purposes of these regulations, means a ship that belongs to the New Zealand Government; and includes a ship that is set aside for, or used by, the New Zealand Defence Force

notified user means a person named in a certificate of notification issued under section 104 of the Act

octopus means a shellfish of the species *Octopus maorum*

overall length means the length of a vessel measured by a straight middle line from the extreme forward end to the extreme aft end of the hull of the vessel

oyster includes a shellfish of the species—

- (a) *Saccostrea glomerata* (formerly known as *Crassostrea glomerata* or *Saxostrea glomerata* and also known as the rock oyster):
- (b) *Crassostrea gigas* (also known as the Pacific oyster):
- (c) *Tiostrea chilensis* (formerly known as *Ostrea lutaria* and also known as the dredge oyster)

packhorse rock lobster means a crustacean of the species *Jasus verreauxi* (also known as the green rock lobster); and includes any part of that fish

paddle crab means a shellfish of the species *Ovalipes catharus*

paua means a shellfish of the following species:

- (a) *Haliotis iris* (ordinary paua):
- (b) *Haliotis australis* (yellow foot paua):
- (c) *Haliotis virginea* (virgin paua)

permit means a fishing permit issued under section 91 of the Act

pilchard means a fish of the species *Sardinops sagax*

pipi means a shellfish of the species *Paphies australis*

prawn killer means a shellfish of the species *Ibacus alticrenatus*

purse seine net or **lampara net** means a net that is operated from a vessel to encircle fish and that is drawn together at the bottom to enclose the fish

red cod means a fish of the species *Pseudophycis bachus*

red moki means a fish of the species *Cheilodactylus spectabilis*

rig means a fish of the species *Mustelus lenticulatus*

ring net means a net that—

- (a) is operated from a vessel in the following manner:
 - (i) a net is laid to surround (whether fully or partially) a school of fish; and

- (ii) once the fish are surrounded, a vessel or some other means is used to scare the fish into the net; and
- (b) has a buoyancy system on the top edge and is weighted on the bottom edge

ring pot, hoop net, or pullpot means a circular frame across which netting is attached

rock lobster pot means a pot, whether baited or not, that is capable of catching and holding or storing rock lobsters; and includes other devices capable of catching, holding, and storing rock lobsters

sailfish means fish of the genera *Istiophorus* spp

salmon means fish of the following species:

- (a) *Salmo salar* (Atlantic salmon):
- (b) *Oncorhynchus tshawytscha* (chinook salmon, previously known as quinnat or king salmon):
- (c) *Oncorhynchus nerka* (sockeye salmon)

saury means a fish of the species *Scomberesox saurus*

scallop, for the purpose of these regulations, means a shellfish of the species *Pecten novaezelandiae*

seabird mitigation measure means a measure or device carried, used, or adopted (as the case may require) for the purpose of avoiding or mitigating the effect of fishing-related seabird mortality, such as (but not limited to)—

- (a) using, adopting, or avoiding a particular fishing practice:
- (b) using or carrying a seabird scaring device

set net includes a gill net, ring net, or other sort of net that acts by enmeshing, entrapping, or entangling fish; but does not include a fyke net or hinaki

shark means a fish of the class *Chondrichthyes*, but excludes *Batoidea*

shark finning means the removal of the fin of any shark and the return of the body of that shark to the sea

shark line means a line deployed directly off longline floats or directly off droplines

skipjack tuna means a fish of the species *Katsuwonus pelamis*

sleeves—

- (a) means material—
 - (i) that is attached externally to the net; and
 - (ii) that acts to lower the effective mesh size of a net; but
- (b) does not include a chafer or chafing gear that is attached to the net

soft shell stage means the state of a rock lobster following moulting where the exoskeleton has not reached full hardness

snapper means a fish of the species *Pagrus auratus* (formerly known as *Chrysophrys auratus*)

South Island fisheries waters, in these regulations, means all New Zealand fisheries waters in the area to the south of a line commencing at the intersection with the boundary of the New Zealand exclusive economic zone at 38°09'S and 169°32'E; then proceeding in a generally easterly direction to a point at 40°02'S and 173°00'E; then proceeding in a south-easterly direction to a point offshore from Kapiti Island at 40°42'S and 174°40'E; then proceeding in a generally southerly direction to a point offshore from Cape Terawhiti at 41°13'S and 174°31'E; then proceeding in a generally southerly direction to a point in Cook Strait at 41°26'S and 174°23'E; then proceeding in an easterly direction to a further point in Cook Strait at 41°32'S and 174°28'E; then proceeding in a generally south-easterly direction to a further point in Cook Strait at 41°35'S and 174°36'E; then proceeding in a generally easterly direction to a point south of Sinclair Head at 41°39'S and 174°58'E; then proceeding in a generally south-easterly direction to a point on the southern side of the Chatham Rise at 44°26'S and 178°26'E; and then proceeding in a generally south-easterly direction to a point that intersects the boundary of the New Zealand exclusive economic zone at 47°46'S and 175°57'W

southern bluefin tuna means a fish of the species *Thunnus maccoyi*; and includes a fish of the species *Thunnus thynnus*

spat means a lifecycle stage or size-range of fish, aquatic life, or seaweed that is declared by the chief executive by notice in the *Gazette* to be spat

spear means a device or implement capable of puncturing the flesh or exoskeleton of fish; but does not include a gaff or similar device used solely for the landing of finfish

spearfish means a fish of the genera *Tetrapturus* spp

spiny rock lobster means a crustacean of the species *Jasus edwardsii* (also known as the red rock lobster); and includes any part of that fish

stalling means the process of setting a net so that fish enclosed or entangled by the net are left stranded by the falling tide or are enclosed or entangled so that, at any stage of the tide, there is an insufficient depth of water at either end of the net to enable the fish to pass from the waters above the net to the waters below the net

static fishing gear means fishing gear not drawn through the water by mechanical means or by hand

surface longlining means the use of a line—

- (a) to which hooks (whether baited or not) are attached; and
- (b) that is suspended by floats; and
- (c) that is not attached to the sea floor

tailing means the process of removing the 6 abdominal segments and the tail fan from the cephalothorax or head or body of a rock lobster

tarakihi means a fish of the species *Nemadactylus macropterus* and *Nemadactylus* sp (also known as king tarakihi)

toheroa means a shellfish of the species *Paphies ventricosa*

trammel net means a net with more than 1 section of mesh, each section of which is attached to a common frame rope, and that catches fish by enmeshing, entrapping, or entangling them

trawl net—

- (a) means a net or part of a net (including any warp, rope, chain, material, or device used in conjunction with, or attached to, that net) that—
 - (i) has a buoyancy system on the top edge; and
 - (ii) is weighted on the bottom edge; and
 - (iii) is operated by being drawn over the bed of waters, or through waters, by 1 or more vessels underway; but
- (b) does not include a Danish seine net

trawling means the use of a trawl net

trevally means a fish of the species *Pseudocaranx dentex* (previously known as *Caranx georgianus*)

tuatua means a shellfish of the species—

- (a) *Paphies subtriangulata*; and
- (b) *Paphies donacina* (also known as southern tuatua)

underwater breathing apparatus means apparatus capable of being used for providing breathable gases underwater; and includes part of that apparatus; but does not include a snorkel

wet, in relation to shark fins, means fins that have not undergone any drying

whitebait net means a net, contrivance, instrument, or device used or capable of being used to take fish commonly known as whitebait

wire trace means a line that is made from, or includes, 1 or more metal strands

yellow-eyed mullet means a fish of the species *Aldrichetta forsteri* (also known as herring)

yellowfin tuna means a fish of the species *Thunnus albacores*.

Regulation 3 **artificially attached**: inserted, on 1 October 2014, by regulation 4 of the Fisheries (Commercial Fishing) Amendment Regulations (No 2) 2014 (LI 2014/279).

Regulation 3 **automatic location communicator**: revoked, on 1 October 2017, by regulation 13 of the Fisheries (Geospatial Position Reporting) Regulations 2017 (LI 2017/155).

Regulation 3 **blue shark**: inserted, on 1 October 2014, by regulation 4 of the Fisheries (Commercial Fishing) Amendment Regulations (No 2) 2014 (LI 2014/279).

Regulation 3 **brown bullhead catfish**: substituted, on 1 April 2007, by regulation 4 of the Fisheries (Commercial Fishing) Amendment Regulations 2007 (SR 2007/32).

Regulation 3 **catch landing return**: revoked, on 1 October 2017, by regulation 51 of the Fisheries (Reporting) Regulations 2017 (LI 2017/154).

Regulation 3 **deepwater clam**: inserted, on 1 October 2006, by regulation 4 of the Fisheries (Commercial Fishing) Amendment Regulations (No 2) 2006 (SR 2006/235).

Regulation 3 **flapper**: inserted, on 6 October 2023, by regulation 66 of the Fisheries Amendment Regulations 2023 (SL 2023/243).

Regulation 3 **geospatial position reporting device**: inserted, on 1 October 2017, by regulation 13 of the Fisheries (Geospatial Position Reporting) Regulations 2017 (LI 2017/155).

Regulation 3 **landing report**: inserted, on 1 October 2017, by regulation 51 of the Fisheries (Reporting) Regulations 2017 (LI 2017/154).

Regulation 3 **method of strengthening**: inserted, on 6 October 2023, by regulation 66 of the Fisheries Amendment Regulations 2023 (SL 2023/243).

Regulation 3 **naturally attached**: inserted, on 1 October 2014, by regulation 4 of the Fisheries (Commercial Fishing) Amendment Regulations (No 2) 2014 (LI 2014/279).

Regulation 3 **New Zealand authorities**: amended, on 1 July 2005, by section 11(4) of the Maritime Transport Amendment Act 2004 (2004 No 98).

Regulation 3 **pilchard**: amended, on 21 February 2014, by regulation 4(2) of the Fisheries (Commercial Fishing) Amendment Regulations 2014 (LI 2014/17).

Regulation 3 **prawn killer**: inserted, on 1 October 2007, by regulation 4 of the Fisheries (Commercial Fishing) Amendment Regulations (No 2) 2007 (SR 2007/252).

Regulation 3 **ring net**: inserted, on 1 October 2020, by regulation 33(1) of the Fisheries (Hector's and Māui Dolphin) Amendment Regulations 2020 (LI 2020/199).

Regulation 3 **seabird mitigation measure**: inserted, on 1 October 2009, by regulation 4 of the Fisheries (Commercial Fishing) Amendment Regulations (No 2) 2009 (SR 2009/243).

Regulation 3 **seabird scaring device**: revoked, on 1 October 2009, by regulation 4 of the Fisheries (Commercial Fishing) Amendment Regulations (No 2) 2009 (SR 2009/243).

Regulation 3 **set net**: amended, on 1 October 2020, by regulation 33(2) of the Fisheries (Hector's and Māui Dolphin) Amendment Regulations 2020 (LI 2020/199).

Regulation 3 **shark**: inserted, on 1 October 2014, by regulation 4 of the Fisheries (Commercial Fishing) Amendment Regulations (No 2) 2014 (LI 2014/279).

Regulation 3 **shark finning**: inserted, on 1 October 2014, by regulation 4 of the Fisheries (Commercial Fishing) Amendment Regulations (No 2) 2014 (LI 2014/279).

Regulation 3 **shark line**: inserted, on 20 December 2015, by regulation 4 of the Fisheries (Commercial Fishing) Amendment Regulations 2015 (LI 2015/268).

Regulation 3 **sleeves**: inserted, on 6 October 2023, by regulation 66 of the Fisheries Amendment Regulations 2023 (SL 2023/243).

Regulation 3 **surface longlining**: inserted, on 3 August 2023, by regulation 4 of the Fisheries (Commercial Fishing) Amendment Regulations 2023 (SL 2023/171).

Regulation 3 **trawl net**: amended, on 1 October 2017, by regulation 4(1) of the Fisheries (Trawling) Amendment Regulations 2017 (LI 2017/157).

Regulation 3 **trawl net** paragraph (a): amended, on 1 October 2017, by regulation 4(2) of the Fisheries (Trawling) Amendment Regulations 2017 (LI 2017/157).

Regulation 3 **wet**: inserted, on 1 October 2014, by regulation 4 of the Fisheries (Commercial Fishing) Amendment Regulations (No 2) 2014 (LI 2014/279).

Regulation 3 **wire trace**: inserted, on 20 December 2015, by regulation 4 of the Fisheries (Commercial Fishing) Amendment Regulations 2015 (LI 2015/268).

4 Certain other regulations prevail over these regulations

These regulations apply subject to other regulations made under the Act that relate to commercial fishing in a specified area of New Zealand fisheries waters.

Part 1

New Zealand fishing vessels and foreign-owned New Zealand fishing vessels

Administrative matters

5 Change of name of vessel

- (1) Except as expressly provided, this regulation and regulations 6 to 15 apply to New Zealand fishing vessels and to foreign-owned New Zealand fishing vessels.
- (2) The name of a vessel must not be changed unless—
 - (a) the operator of the vessel has made written application to the chief executive; and
 - (b) the chief executive gives written authority for the change of name of the vessel.
- (3) When considering an application under subclause (2), the chief executive must be satisfied that a change of name of the vessel will not cause undue confusion.
- (4) Despite subclause (3), if a vessel is registered under the Ship Registration Act 1992, its name must not be altered except in accordance with that Act.

Compare: SR 1986/215 r 6

6 Changes of information must be notified

Not later than 1 calendar month after the information provided in an application for a permit, authority, approval, permission, licence, or certificate, has changed, the holder of the permit, authority, approval, permission, licence, or certificate must give notice in writing to the chief executive of the new information.

7 Certificate of registration, certificate of notification, and fishing permits must be produced

The operator, notified user, or master of a vessel must ensure that the certificate of registration, certificate of notification (if any), and all relevant fishing permits are—

- (a) kept on board the registered vessel; and
- (b) maintained in a legible condition; and

(c) produced immediately on the request of a fishery officer.

Compare: SR 1986/215 r 11

8 Alteration and replacement of certificate of registration, certificate of notification, or fishing permit

- (1) No person may alter, deface, or make illegible a certificate of registration, certificate of notification, or fishing permit, or a replacement of any of those documents issued under subclause (3).
- (2) Despite subclause (1), the chief executive may alter a certificate of registration, certificate of notification, or fishing permit, or a replacement of any of those documents issued under subclause (3).
- (3) If a certificate of registration, certificate of notification, or fishing permit is lost, destroyed, or so damaged as to make it illegible, the holder of the certificate of registration, certificate of notification, or fishing permit (as the case may be) must apply to the chief executive for a replacement, with the prescribed fee (if any).

Compare: SR 1986/215 r 12

Marking of vessels

9 Name of vessel

An operator of a vessel must ensure that, within 7 days after the registration of the vessel or before the vessel is used for fishing, whichever is the earlier, the name of the vessel is marked in contrasting colours on both sides of the hull with clear and legible letters and figures, as appropriate, that are not less than—

- (a) 250 mm in height; and
- (b) 125 mm across; and
- (c) 25 mm stroke width; and
- (d) 50 mm from any other letter or figure.

Compare: SR 1986/215 r 13

10 Marking of vessels with registration number

- (1) This regulation does not apply to foreign-owned New Zealand fishing vessels or to vessels registered under section 105 of the Act.
- (2) Subject to subclause (1), an operator of a vessel that is less than 28 m in overall length must ensure that, within 7 days after the registration of the vessel or before the vessel is used for fishing, whichever is the earlier,—
 - (a) the vessel is marked with figures showing the registration number of the vessel; and
 - (b) those figures are painted on both sides of the forward plane of the hull in accordance with Schedule 4.

- (3) If a vessel other than a vessel described in subclause (1) ceases to be registered, the operator must, within 7 days of its registration ceasing, remove from the vessel the registration number required by subclause (2).

Compare: SR 1986/215 rr 14(1), 19

11 Marking of vessels with international call sign

- (1) The operator of a foreign-owned New Zealand fishing vessel, a vessel registered under section 105 of the Act, or a vessel that is 28 m or more in overall length must ensure that, within 7 days after the registration of the vessel or before the vessel is used for fishing, whichever is the earlier, the vessel is marked with the vessel's international call sign.
- (2) The markings must be painted amidship on both sides of the hull immediately below the gunwale in accordance with Schedule 4.
- (3) If a vessel described in subclause (1) ceases to be registered, the operator must, within 7 days of its registration ceasing, remove from the vessel any letters or figures that identify that vessel as a vessel registered under the Act, but must not remove the international call sign required by subclause (1).

Compare: SR 1986/215 rr 14(2), 19

12 Colour of letters and figures

The figures of the registration number and, if required, the letters and figures of the international call sign must be painted on the vessel in white on a black background or in black on a white background, whichever produces the greater contrast with the colour of the hull.

Compare: SR 1986/215 r 15

13 Letters and figures must be maintained

An operator, notified user, or master of a vessel must ensure that, while the vessel is registered,—

- (a) the letters and figures of the name, registration number, and any international call sign are not removed, obscured, or obliterated from the vessel; and
- (b) the appropriate letters and figures are maintained in accordance with regulations 10 to 12 and Schedule 4.

Compare: SR 1986/215 r 17

14 Display of false or misleading letters or figures

- (1) No person may display on a vessel any letter, figure, or combination of letters and figures that is intended to cause, or that may reasonably cause, any person to believe that the vessel is any other vessel or is not a New Zealand fishing vessel or foreign-owned New Zealand fishing vessel.
- (2) No person may display on a vessel that is not registered under section 103 or section 105 of the Act any letter, figure, or combination of letters and figures

that is intended to cause, or that may reasonably cause, any person to believe that the vessel is registered or is any other registered vessel.

Compare: SR 1986/215 r 20

15 Alternative position for marking vessels

- (1) It is sufficient compliance with regulations 10 to 13 and Schedule 4 if the operator of a vessel described in subclause (2) ensures that the letters and figures are marked and maintained on both sides of the hull or superstructure of the vessel in the position and as nearly as practicable to the size and manner approved in writing by a fishery officer.
- (2) The vessels covered by subclause (1) are—
 - (a) a vessel used for squid or any other type of fishing on which any letters or figures required by regulations 10 to 13 and Schedule 4 are likely to be quickly obscured or obliterated; or
 - (b) a vessel with a hull shaped so that any letters or figures required by regulations 10 to 13 and Schedule 4 are likely to be obscured or obliterated.

Compare: SR 1986/215 r 18

16 Marking of tenders

- (1) All tenders must—
 - (a) be marked on both sides of the hull with clear and legible letters and figures in accordance with Schedule 4; and
 - (b) have the number on the tender preceded by the letter “T” with a hyphen (“T-”); and
 - (c) have the figures and letters of the tender number painted in a colour that produces the greatest contrast with the colour of the hull; and
 - (d) if a registered vessel operates more than 1 tender, have a number on the tender between the letter “T” and the hyphen to denote the number of the tender (for example, “T1-”, “T2-”, etc).
- (2) A tender must not be simultaneously marked as the tender of more than 1 registered vessel.
- (3) A tender must not be simultaneously marked as a tender and as a registered vessel.
- (4) The operator of a registered vessel must ensure that, in relation to any tender used in support of that vessel, the required figures and letters are maintained and are not removed, obscured, or obliterated.
- (5) A person must not display on any tender any figure, letter, or combination of letters or figures in a way that is intended to cause, or that may reasonably cause, a person to believe that the tender is not a tender or that the tender is another New Zealand fishing vessel or tender.

- (6) The operator of a vessel must ensure that tenders used in support of that vessel do not display the markings required for tenders under this regulation if the vessel is no longer registered under the Act.

Part 2

Conditions applying to foreign-owned New Zealand fishing vessels and registered fish carriers

Conditions of general application to certificates of registration

17 Reporting obligations

- (1) Unless otherwise specified, this regulation and regulations 18 to 23 apply to the following fishing vessels:
- (a) foreign-owned New Zealand fishing vessels; and
 - (b) fish carriers registered under section 105 of the Act.
- (2) Unless otherwise specified, the obligations under this regulation and regulations 18 to 29 fall on the operator, notified user, or master of a vessel, whichever is appropriate in the circumstances.
- (3) A ship's log, in English, must be maintained on board a vessel at all times when it is in New Zealand fisheries waters to record—
- (a) every instruction, direction, or requirement communicated to the vessel by New Zealand authorities; and
 - (b) events on board, or in relation to, the vessel or its operation.
- (4) A copy of every report supplied to the Fisheries Communication Centre by a vessel must be kept in a permanent and legible form on board the vessel for a period of not less than 6 months after the end of the fishing year to which the report relates and must be noted in English in the ship's logbook.
- (5) If a company in whose name a vessel is registered no longer has an interest in the vessel, the company must retain the reports for the remainder of the 6-month period referred to in subclause (4).
- (6) A person must be available at all times to act as an interpreter from English to the language of the operator, notified user, or master of the vessel and from that other language to English.
- (7) Once a vessel is registered under the Act, and before commencing fishing for the first time in New Zealand fisheries waters, the operator, notified user, or master of the vessel must—
- (a) notify the Fisheries Communication Centre; and
 - (b) be cleared to fish by a fishery officer, who may undertake a port inspection before giving that clearance.

- (8) Except where subclause (9) applies, a vessel intending to leave New Zealand fisheries waters must first be given a clearance to leave New Zealand fisheries waters by a fishery officer and the vessel must then proceed directly to the high seas.
- (9) If the registration of a vessel under the Act expires or is cancelled, the vessel must be given a clearance to leave New Zealand fisheries waters by a fishery officer and the vessel must then proceed directly to the high seas.
- (10) A vessel cleared to leave New Zealand fisheries waters under subclause (8) or subclause (9) must, as it leaves the port from which it obtained clearance, notify (in New Zealand Standard Time) the Fisheries Communication Centre of—
 - (a) its intended time and position of departure from New Zealand fisheries waters; and
 - (b) its time of departure from the port.

18 Carriage and transfer of fishing equipment

- (1) When a fishing vessel is within an area where it is not permitted to fish, all fishing gear must be stowed so that it is not readily available for fishing.
- (2) Before fishing gear, supplies, services, or personnel may be transferred to or from a foreign-owned New Zealand fishing vessel, a fish carrier, or a foreign fishing vessel,—
 - (a) the prior approval of the chief executive must be obtained through the Fisheries Communication Centre; and
 - (b) the transfer, if approved, must comply with the conditions of the approval.

19 Transshipment of fish

- (1) This regulation applies to a fishing vessel if fish are—
 - (a) transhipped at sea under section 110 of the Act; or
 - (b) transhipped at port to another vessel; or
 - (c) landed but not delivered to a licensed fish receiver and loaded aboard another vessel or aircraft for export from New Zealand.
- (2) The operator, notified user, or master of a vessel must—
 - (a) obtain prior approval for a transshipment or landing from the chief executive; and
 - (b) comply with this regulation and any conditions that the chief executive sees fit to impose.
- (3) Advance notice must be given to the Fisheries Communication Centre as follows:

- (a) not less than 10 days, in the case of an intention to carry out a transshipment at sea; or
 - (b) not less than 3 days, in the case of an intention to carry out a transshipment at a port; or
 - (c) not less than 3 days, in the case of an intention to land and load fish for export.
- (4) A transshipment or landing must be supervised by an observer or fishery officer.
- (5) Before a transshipment or landing commences, 3 cargo plans must—
- (a) be completed on the approved forms and in accordance with the explanatory notes; and
 - (b) be made available to the supervising observer or fishery officer prior to the commencement of the transshipment or landing; and
 - (c) be supplied with a diagram of the vessel, depicting the holds of the vessel, in accordance with the explanatory notes.
- (6) All cartons containing fish being transhipped must be legibly marked, either directly or with a label, in accordance with the requirements of the Industry Agreed Inspection Standard (IAIS) 004.1.
- (7) In a transshipment or landing, each sling load must be consistent as to the number of fish cartons it carries unless a change in the number of cartons in a sling load is first approved by the supervising observer or fishery officer.
- (8) All fish in each carton of a sling load must be of the same size, weight, and species, and in the same state, unless otherwise approved by the supervising observer or fishery officer.
- (9) No vessel may fish or process fish during transshipment or until the transshipment or a landing report is completed, whichever is the sooner.
- (10) A transshipment of fish from a foreign-owned New Zealand fishing vessel to a licensed foreign fish carrier must be carried out within the exclusive economic zone, but only within that part of the exclusive economic zone that lies outside the territorial sea, as defined in the Territorial Sea, Contiguous Zone, and Exclusive Economic Zone Act 1977.
- (11) In a transshipment or landing, all embarkation and disembarkation, accommodation, and food costs of the Ministry observer or fishery officer must be supplied free of charge to the Ministry, and the operator must pay the transshipment supervision fee specified in Schedule 2.

Regulation 19(9): amended, on 1 October 2017, by regulation 51 of the Fisheries (Reporting) Regulations 2017 (LI 2017/154).

20 Communications

- (1) If a New Zealand Government ship approaches a fishing vessel, the vessel must set watch on HF SSB frequency 2182 kHz or VHF channel 16.

- (2) A New Zealand Government ship may also communicate by a flag hoist or with a flashing light.
- (3) If a New Zealand Government aircraft flies past a vessel at low altitude and parallel to the vessel's track, with its undercarriage extended and landing lights on, the vessel must set watch on HF SSB frequency 2182 kHz or VHF channel 16.
- (4) A New Zealand Government aircraft may also communicate with a flashing light.
- (5) If a helicopter approaches by hovering alongside the stern of a vessel, the vessel must set watch on HF SSB frequency 2182 kHz or VHF channel 16.
- (6) If radiocommunication is unavailable in the case of a helicopter approach, the helicopter must communicate its requirement that the vessel prepare for helicopter transfer by circling the vessel once, hovering alongside the stern of the vessel, and hovering over the particular area where the transfer is to take place.
- (7) A vessel must reply when called by a New Zealand Government ship or aircraft, or by a helicopter.

21 Boarding procedures

- (1) The operator, notified user, or master of a fishing vessel must comply with this regulation when requested to prepare for the vessel to be boarded by an observer or fishery officer.
- (2) The vessel must be manoeuvred by any or all of the following means as may be appropriate to facilitate the boarding:
 - (a) by stopping the vessel:
 - (b) by providing a lee:
 - (c) by heading into the sea:
 - (d) by proceeding downwind and into the sea.
- (3) If the vessel is in motion while being boarded, its speed must be commensurate with the weather conditions so as to permit the vessel to be boarded in a safe and professional manner.
- (4) The vessel must provide a ladder, fenders, securing lines, and adequate lighting for persons boarding the vessel, with the ladder secured so that it is free of all discharge outlets, and the lighting must not hinder the manoeuvring of the vessel or the boats from which the boarding is taking place.
- (5) The master must provide any assistance that is required by persons boarding or leaving the vessel.
- (6) Consideration for the safety of the vessel must not compromise the safety of persons boarding or leaving the vessel.

22 Helicopter transfer

- (1) The operator, notified user, or master of a fishing vessel must comply with this regulation when requested to prepare for a helicopter transfer.
- (2) The transfer operation must be carried out,—
 - (a) if the stern area is free from obstruction and is suitable for a helicopter transfer, in the stern area of the vessel; or
 - (b) if the stern area is not clear, in the bow area, which must be prepared for a helicopter transfer.
- (3) Before a transfer operation begins, the transfer area must be cleared of all loose material and particles, including tarpaulins, winch covers, cloths, light packing, papers, and objects that may be lifted from the deck or surrounding structures by a helicopter downdraught and all rigging on the transfer area must be secured.
- (4) The vessel must turn into the wind and proceed at a speed of approximately 5 knots on a steady course prior to and during the transfer.
- (5) The helicopter winch cable must never be attached or secured to a part of the fishing vessel or to equipment or a structure on the vessel.
- (6) Consideration for the safety of the vessel must not compromise the safety of persons involved in a helicopter transfer.

23 Facilities for observers

Observers must be provided with on-board facilities that comply with the requirements of section 223 of the Act and regulation 33 of the Fisheries (Foreign Fishing Vessel) Regulations 2001.

Additional conditions applying to particular types of fishing vessels: Tuna longline fishing

24 Areas closed to longliners

- (1) This regulation and regulation 25 apply to foreign-owned New Zealand fishing vessels that are used for any tuna longline fishing.
- (2) Vessels of the kind referred to in subclause (1) must not—
 - (a) fish in the New Zealand territorial sea at any time;
 - (b) fish in fishery management areas 1 and 9 between 1 October of any year and 31 May of the following year.

Regulation 24(2)(b): amended, on 6 October 2023, by regulation 67 of the Fisheries Amendment Regulations 2023 (SL 2023/243).

25 Tagging of billfish caught by tuna longliners

The operator, notified user, or master of a vessel used for tuna longline fishing must—

- (a) first tag and then release—
 - (i) marlin taken alive in New Zealand fisheries waters; and
 - (ii) sailfish and spearfish taken alive in fishery management areas 1 and 9; and
- (b) provide information on tagged and dead billfish to the chief executive in accordance with the Ministry's tagging programme.

Regulation 25(a)(ii): amended, on 6 October 2023, by regulation 68 of the Fisheries Amendment Regulations 2023 (SL 2023/243).

26 Application for approval for southern bluefin tuna longlining

[Revoked]

Regulation 26: revoked, on 1 October 2004, by regulation 3 of the Fisheries (Commercial Fishing) Amendment Regulations (No 2) 2004 (SR 2004/284).

Skipjack tuna purse seiners

27 Conditions applying to skipjack tuna purse seiners

(1AA) This regulation and regulation 28 apply to foreign-owned New Zealand fishing vessels that are used as skipjack tuna purse seiners.

- (1) The operator, notified user, or master of a foreign-owned New Zealand fishing vessel that is a skipjack tuna purse seiner must provide notice to the Fisheries Communication Centre 24 hours in advance of an intention to enter or leave New Zealand fisheries waters.
- (2) A skipjack tuna purse seiner must not fish in the New Zealand territorial sea or in the area between a line due east of Cape Brett (at 35°10.46'S and 174°20.05'E) and a line due north of North Cape (at 34°24.80'S and 173°02.80'E), extending an additional 6 nautical miles beyond the outer limits of the New Zealand territorial sea.

Regulation 27(1AA): inserted, on 11 July 2002, by regulation 3 of the Fisheries (Commercial Fishing) Amendment Regulations 2002 (SR 2002/157).

28 Returns required in relation to skipjack tuna purse seining

- (1) The operator, notified user, or master of a skipjack tuna purse seiner must maintain a daily purse seine log, a copy of which must be returned to a representative of the Ministry of Fisheries before the vessel leaves New Zealand fisheries waters.
- (2) A helicopter or fixed wing aircraft pilot flying in conjunction with a skipjack tuna purse seiner must complete a return of aerial sightings on the approved form for each flight undertaken in support of fishing operations and return the completed forms to the chief executive before the vessel leaves New Zealand fisheries waters.

Squid jiggers

29 Conditions applying to squid jiggers

Foreign-owned New Zealand fishing vessels that are squid jiggers must not fish in the following areas:

- (a) the New Zealand territorial sea; and
- (b) the area of Tasman Bay enclosed by a line commencing at a point at 40°19.437'S and 173°00.875'E; and then proceeding in a south-easterly direction to a point at 40°27.645'S and 174°00'E; and then proceeding in a south-westerly direction along the outer limits of the territorial sea of New Zealand to the first-mentioned point.

Regulation 29(b): amended, on 29 January 2020, by regulation 4 of the Fisheries (Co-ordinates) Amendment Regulations 2019 (LI 2019/292).

Part 3

Restrictions on commercial fishing for certain species

Marlin

30 Restrictions on taking marlin

- (1) This regulation applies subject to regulation 25.
- (2) Except as provided in this regulation, commercial fishers must not possess marlin taken from New Zealand fisheries waters.
- (3) No person may sell or possess for sale marlin taken from New Zealand fisheries waters.
- (4) Commercial fishers who take marlin—
 - (a) may tag them with a tag supplied by the chief executive, but must return them to the sea; or
 - (b) if the marlin has been tagged already, may retain and land the marlin, but must surrender them to a fishery officer; or
 - (c) in other cases, must return them, whether alive or dead, to the sea.
- (5) A fishery officer who receives tagged marlin under subclause (4) must dispose of them as directed by the chief executive.

Compare: SR 1986/215 r 20A

Finfish

31 Minimum finfish length and net mesh size

- (1) Commercial fishers must not use or possess nets whose net mesh size is smaller than that specified for each species in the table in subclause (6).

- (1A) The minimum set net mesh size in the table in subclause (6) applies only when the relevant species of fish is the target species.
- (2) The restriction in subclause (1) does not apply if purse seine or lampara nets are used by commercial fishers to target albacore, anchovy, blue mackerel, jack mackerel, garfish, kahawai, koheru, pilchard, saury, skipjack tuna, trevally, or yellowfin tuna.
- (2A) The restriction in subclause (1) does not apply to trawl nets (*see* regulation 71).
- (3) Despite subclause (1), commercial fishers may target koi or brown bullhead catfish with fyke nets, so long as the net mesh size is not less than 12 mm.
- (4) *[Revoked]*
- (5) No person may sell, possess for sale, or process for sale finfish that are smaller than the length specified in the table in subclause (6) for those species.
- (6) Commercial fishers must not take or possess finfish that are smaller than the length specified in the following table for each species:

Species of fish	Minimum net mesh size (mm)	Minimum fish length (cm)
Blue cod	-	33
Blue moki	115	40
Butterfish	108	35
Elephant fish	150	-
Flatfishes (except sand flounder)	100	25
Garfish (piper)	25	-
Kahawai	85	-
Kingfish	100	65
Mullet	85	-
Pilchard	25	-
Red cod	100	25
Red moki	115	40
Rig	150	-
Sand flounder	100	23
Snapper	100	25
Tarakihi	100	25
Trevally	100	25
Yellow-eyed mullet	25	-
All others	100	-

- (7) This regulation does not apply in relation to eels.

Compare: SR 1986/215 r 21

Regulation 31 heading: amended, on 20 December 2015, by regulation 5(1) of the Fisheries (Commercial Fishing) Amendment Regulations 2015 (LI 2015/268).

Regulation 31(1): amended, on 1 October 2017, by regulation 5(1) of the Fisheries (Trawling) Amendment Regulations 2017 (LI 2017/157).

Regulation 31(1): amended, on 1 October 2017, by regulation 5(2) of the Fisheries (Trawling) Amendment Regulations 2017 (LI 2017/157).

Regulation 31(1A): inserted, on 6 October 2023, by regulation 69(1) of the Fisheries Amendment Regulations 2023 (SL 2023/243).

Regulation 31(2): amended, on 6 October 2023, by regulation 69(2) of the Fisheries Amendment Regulations 2023 (SL 2023/243).

Regulation 31(2A): inserted, on 1 October 2017, by regulation 5(3) of the Fisheries (Trawling) Amendment Regulations 2017 (LI 2017/157).

Regulation 31(3): replaced, on 6 October 2023, by regulation 69(3) of the Fisheries Amendment Regulations 2023 (SL 2023/243).

Regulation 31(4): revoked, on 20 December 2015, by regulation 5(2) of the Fisheries (Commercial Fishing) Amendment Regulations 2015 (LI 2015/268).

Regulation 31(5): amended, on 20 December 2015, by regulation 5(3) of the Fisheries (Commercial Fishing) Amendment Regulations 2015 (LI 2015/268).

Regulation 31(6) table Eels: revoked, on 1 October 2004, by regulation 4(2) of the Fisheries (Commercial Fishing) Amendment Regulations (No 2) 2004 (SR 2004/284).

Regulation 31(7): inserted, on 20 December 2015, by regulation 5(4) of the Fisheries (Commercial Fishing) Amendment Regulations 2015 (LI 2015/268).

Shellfish

32 Size limits on shellfish

- (1) Commercial fishers must not take or possess species of shellfish if the shell, whether entire, chipped, or broken, is less than the length specified for that species in the following table:

Species	Minimum length (mm)
Paua (ordinary)	125
(yellowfoot)	80
Scallops	100

- (2) Commercial fishers must not take or possess dredge oysters that may be passed through a rigid circular metal ring with a clear inside diameter of 58 mm.
- (3) No person may sell, possess for sale, or process for sale shellfish or dredge oysters less than the length or size respectively specified for the species.

Compare: SR 1986/215 r 22

33 Restrictions on opening shellfish

- (1) Commercial fishers taking or possessing shellfish must ensure that they remain unshelled until they are delivered either to the first point of sale after being taken or to a processing factory.

- (2) Commercial fishers or persons engaged in the business of fish processing must not land or begin shelling, shucking, or processing dead shellfish.

Compare: SR 1986/215 r 23

34 Restrictions on taking oysters

Commercial fishers must not take or possess oysters taken from South Island fisheries waters between 1 September in any year and the last day of February in the following year (both days inclusive).

Compare: SR 1986/215 r 24

35 Restrictions on taking and possessing scallops

Commercial fishers must not take or possess scallops taken between 15 February and 14 July in any year (both days inclusive).

Compare: SR 1986/215 r 25

36 Taking and possessing toheroa prohibited

- (1) Commercial fishers must not take or possess toheroa.
- (2) No person may sell, or possess for sale, or process for sale toheroa.

Compare: SR 1986/215 r 26

Rock lobster

37 Size limit on rock lobster

- (1) Commercial fishers must not take or possess undersize rock lobsters or the tails of undersize rock lobsters.
- (2) No person may sell, possess for sale, or process for sale undersize rock lobsters or the tails of undersize rock lobsters.
- (3) A rock lobster, whether alive, dead, cooked, frozen, or chilled, is undersize for the purposes of this regulation if the tail is—
- (a) less than 60 mm wide, in the case of a female spiny rock lobster, when measured in accordance with regulation 38:
 - (b) less than 54 mm wide, in the case of a male spiny rock lobster, when measured in accordance with regulation 38:
 - (c) less than 90 mm wide, in the case of a female packhorse rock lobster, when measured in accordance with regulation 38:
 - (d) less than 84 mm wide, in the case of a male packhorse rock lobster, when measured in accordance with regulation 38.

Compare: SR 1986/215 r 27

Regulation 37(3)(c): replaced, on 1 April 2024, by regulation 70(1) of the Fisheries Amendment Regulations 2023 (SL 2023/243).

Regulation 37(3)(d): inserted, on 1 April 2024, by regulation 70(2) of the Fisheries Amendment Regulations 2023 (SL 2023/243).

38 Method of measurement of rock lobster tail

- (1) For the purposes of these regulations, the width of the tail of a rock lobster is the distance measured in a straight line from the tip of one primary pleural spine on the second abdominal segment of the tail to the tip of the other primary pleural spine on that segment.
- (2) In a dispute as to whether or not a rock lobster is undersize, the matter must be determined by measuring the width of the tail—
 - (a) in accordance with this regulation; and
 - (b) using the tail-width measuring device described in subclause (3) and depicted in Schedule 1.
- (3) The tail-width measuring device must be a device—
 - (a) supplied by the chief executive and must bear the letters “DSIR”, “MAF”, or a Ministry mark and an identifying number; and
 - (b) consisting of a handle with an attachment comprising 2 sets of rigid caliper-type arms, as follows:
 - (i) each set of arms must have one arm with a raised projection (the **measuring bar**); and
 - (ii) the second arm must be marked with a line 2 mm away from, and parallel to, the projected edge of the central column of the device, and be marked with—
 - (A) the expressions “60” and “F”, for measuring the tail of a female spiny rock lobster; or
 - (B) the expressions “54” and “M”, for measuring the tail of a male spiny rock lobster; or
 - (C) the expressions “90” and “F”, for measuring the tail of a female packhorse rock lobster; or
 - (D) the expressions “84” and “M”, for measuring the tail of a male packhorse rock lobster.
- (4) In every case, the tail width must be measured with the relevant set of caliper-type arms in the following manner:
 - (a) the rock lobster or tail must be held with the ventral side uppermost;
 - (b) the tip of one of the primary pleural spines on the second abdominal segment must be brought into contact with the inside face of the longer section of the measuring bar (in this position the measuring bar being used will not normally be visible to the person measuring);
 - (c) with the tip of the spine in this position, the measuring device must be rotated to determine whether or not there is a position in which the tip of the other primary pleural spine on the second abdominal segment will reach that part of the inside edge of the other arm of the device that

extends from the line referred to in subclause (3)(b)(ii) to the unattached end of the arm (the **measuring edge**).

- (5) No more pressure must be applied to the tail or to the measuring device than is necessary to make the measurement specified in subclause (4).
- (6) The rock lobster will be undersize if, when the tip of one spine is in contact with the inside face of the longer section of the measuring bar, the tip of the other spine fails to reach the measuring edge of the other relevant arm of the measuring device.

Regulation 38: replaced, on 1 April 2024, by regulation 71 of the Fisheries Amendment Regulations 2023 (SL 2023/243).

39 Instruments used for measuring rock lobster

- (1) Measurement of the tail width of a rock lobster does not comply with regulation 38 if the tail-width measuring device is altered, added to, or adapted so that it decreases the distance between the relevant measuring bar and measuring edge after the device was supplied by the chief executive.
- (2) Measurement of the tail width of a rock lobster by a tail-width measuring device described in regulation 38(3) does not comply with this regulation unless the device is referred to in a report—
 - (a) issued by either the Measurement Standards Laboratory of New Zealand (as defined in regulation 2 of the National Standards Regulations 1976) or by an inspector or an accredited person (as those terms are defined in section 2 of the Weights and Measures Act 1987); and
 - (b) certifying the device as an accurate tail-width measuring device.
- (3) The diagrams in Schedule 1 depict the tail-width measuring device and the parts of the body of the rock lobster (other than the exoskeleton), and the physical features by which male and female rock lobsters may be distinguished.

Compare: SR 1986/215 r 28(5), (5A), (6), Schedule 1

Regulation 39 heading: amended, on 1 April 2024, by regulation 72(1) of the Fisheries Amendment Regulations 2023 (SL 2023/243).

Regulation 39(1): amended, on 1 April 2024, by regulation 72(2) of the Fisheries Amendment Regulations 2023 (SL 2023/243).

Regulation 39(2): amended, on 1 April 2024, by regulation 72(2) of the Fisheries Amendment Regulations 2023 (SL 2023/243).

Regulation 39(3): amended, on 1 April 2024, by regulation 72(2) of the Fisheries Amendment Regulations 2023 (SL 2023/243).

40 Method of measurement of packhorse rock lobster

[Revoked]

Regulation 40: revoked, on 1 April 2024, by regulation 73 of the Fisheries Amendment Regulations 2023 (SL 2023/243).

41 Taking, possessing, processing, and sale of certain rock lobsters prohibited

- (1) This regulation applies to a rock lobster if—
- (a) that rock lobster is carrying external eggs; or
 - (b) external eggs have been removed from that rock lobster by artificial means; or
 - (c) an egg-bearing appendage or pleopod or a part of it has been removed from that rock lobster or the tail is in such a state that the sex of the rock lobster cannot be determined; or
 - (d) that rock lobster is in the soft-shell stage; or
 - (e) *[Revoked]*
 - (f) *[Revoked]*
 - (g) the calcified bar or a part of the exoskeleton (the outer shell of the tail) of the second abdominal segment of the tail is fractured; or
 - (h) a part of a primary pleural spine of the second abdominal segment is broken.
- (1A) However, subclause (1)(g) and (h) does not apply to—
- (a) a spiny rock lobster that—
 - (i) weighs 600 g or more; or
 - (ii) has a carapace length of 110 mm or more; or
 - (b) a packhorse rock lobster that—
 - (i) weighs 2 kg or more; or
 - (ii) has a tail length of 216 mm or more.
- (2) Commercial fishers must not take or possess rock lobsters to which this regulation applies.
- (3) No person may sell, possess for sale, or process for sale rock lobsters to which this regulation applies.

Compare: SR 1986/215 r 29

Regulation 41(1)(e): revoked, on 6 October 2023, by regulation 74(1) of the Fisheries Amendment Regulations 2023 (SL 2023/243).

Regulation 41(1)(f): revoked, on 6 October 2023, by regulation 74(1) of the Fisheries Amendment Regulations 2023 (SL 2023/243).

Regulation 41(1)(g): replaced, on 6 October 2023, by regulation 74(2) of the Fisheries Amendment Regulations 2023 (SL 2023/243).

Regulation 41(1)(h): inserted, on 6 October 2023, by regulation 74(2) of the Fisheries Amendment Regulations 2023 (SL 2023/243).

Regulation 41(1A): inserted, on 6 October 2023, by regulation 74(3) of the Fisheries Amendment Regulations 2023 (SL 2023/243).

42 Rock lobsters must be landed and processed alive

- (1) Commercial fishers must not—

- (a) land rock lobsters unless the rock lobsters are alive; or
 - (b) tail rock lobsters on board a vessel.
- (2) A person processing rock lobsters for sale must not tail or begin to process them unless the rock lobsters are alive.

Compare: SR 1986/215 r 30

Salmon

43 Taking or possession of salmon prohibited

- (1) Commercial fishers must not take or possess salmon.
- (2) Despite subclause (1), commercial fishers who take tagged salmon must retain and land the salmon and surrender them to a fishery officer.
- (3) Subclause (1) does not apply if—
 - (a) a commercial fisher takes salmon as an inevitable consequence of the lawful taking of other fish; and
 - (b) the salmon, when taken, are dead or so damaged as to be unlikely to survive being returned to the water; and
 - (c) the commercial fisher notifies a fishery officer as soon as practicable of the taking of the salmon; and
 - (d) the commercial fisher surrenders ownership of the salmon to the Crown and disposes of the fish in accordance with the directions of a fishery officer.
- (4) No person may sell or possess salmon for sale.
- (5) Despite subclause (4), a licensed fish receiver may sell or possess for sale salmon surrendered to the Crown and disposed of under subclause (3)(d).

Compare: SR 1986/215 r 30A

Black coral

44 Taking and possession of black coral prohibited

- (1) Commercial fishers must not take or possess black coral.
- (2) No person may sell, possess for sale, or process for sale black coral.

Compare: SR 1986/215 r 31

Marine turtles

45 Taking and possession of marine turtles prohibited

- (1) Commercial fishers must not take marine turtles from New Zealand fisheries waters or possess marine turtles taken from those waters.
- (2) Subclause (1) does not apply if—
 - (a) marine turtles are accidentally taken; or

- (b) an authority or permit has been given to take or possess marine turtles either—
- (i) under section 53 or section 56 of the Wildlife Act 1953; or
 - (ii) under section 14 of the Trade in Endangered Species Act 1989.

Compare: SR 1986/215 r 31A

Regulation 45(2)(a): amended, on 1 April 2008, by regulation 4 of the Fisheries (Commercial Fishing) Amendment Regulations 2008 (SR 2008/26).

46 **Uninjured turtles must be immediately returned to waters from which taken**

Any marine turtle taken by a commercial fisher that is not injured must immediately be returned to the waters from which it was taken.

Regulation 46: substituted, on 1 April 2008, by regulation 5 of the Fisheries (Commercial Fishing) Amendment Regulations 2008 (SR 2008/26).

47 **Injured turtles**

Injured or drowning marine turtles must be treated in accordance with standards and specifications issued by the chief executive from time to time.

Regulation 47: substituted, on 1 April 2008, by regulation 5 of the Fisheries (Commercial Fishing) Amendment Regulations 2008 (SR 2008/26).

48 **Circulars relating to marine turtles**

- (1) The chief executive may issue, amend, or revoke a circular specifying the standards and specifications that commercial fishers must comply with in handling injured or drowning marine turtles that they have accidentally taken.
- (2) Before issuing, amending, or revoking a circular, the chief executive must consult, to the extent that is practicable in the circumstances, with any persons or organisations considered by the chief executive to be representative of the classes of persons or organisations likely to be substantially affected by the circular.
- (3) A circular issued under subclause (1) is secondary legislation (*see* Part 3 of the Legislation Act 2019 for publication requirements).

Legislation Act 2019 requirements for secondary legislation made under this regulation

Publication	The maker must publish it in the <i>Gazette</i>	LA19 ss 73, 74(1)(a), Sch 1 cl 14
Presentation	It is not required to be presented to the House of Representatives because a transitional exemption applies under Schedule 1 of the Legislation Act 2019	LA19 s 114, Sch 1 cl 32(1)(a)
Disallowance	It may be disallowed by the House of Representatives	LA19 ss 115, 116

This note is not part of the secondary legislation.

Regulation 48: substituted, on 1 April 2008, by regulation 5 of the Fisheries (Commercial Fishing) Amendment Regulations 2008 (SR 2008/26).

Regulation 48(1): amended, on 28 October 2021, by regulation 28(1) of the Legislation Act (Sub-delegated Secondary Legislation) Regulations 2021 (LI 2021/248).

Regulation 48(3): inserted, on 28 October 2021, by regulation 28(2) of the Legislation Act (Sub-delegated Secondary Legislation) Regulations 2021 (LI 2021/248).

49 Turtle catches must be reported

[Revoked]

Regulation 49: revoked, on 1 October 2008, by regulation 6(2) of the Fisheries (Commercial Fishing) Amendment Regulations 2008 (SR 2008/26).

Eels

50 Maximum legal weight for eels taken from New Zealand fisheries waters

- (1) Commercial fishers must not take or possess any shortfinned or longfinned eel weighing more than 4 kg.
- (2) No person may sell, possess for sale, or process for sale any shortfinned or longfinned eel weighing more than 4 kg.

Regulation 50: substituted, on 1 April 2007, by regulation 5 of the Fisheries (Commercial Fishing) Amendment Regulations 2007 (SR 2007/32).

51 Minimum weight for eels taken from New Zealand fisheries waters

- (1) Commercial fishers must not take or possess any eel weighing less than 220 g.
- (2) No person may sell, possess for sale, or process for sale any eel weighing less than 220 g.

Regulation 51: replaced, on 20 December 2015, by regulation 6 of the Fisheries (Commercial Fishing) Amendment Regulations 2015 (LI 2015/268).

52 Use of fyke nets to take eels in South Island fisheries waters

[Revoked]

Regulation 52: revoked, on 1 October 2013, by regulation 4 of the Fisheries (Commercial Fishing) Amendment Regulations 2013 (SR 2013/325).

Brown bullhead catfish

Heading: inserted, on 1 April 2007, by regulation 6 of the Fisheries (Commercial Fishing) Amendment Regulations 2007 (SR 2007/32).

52A Sale of live brown bullhead catfish prohibited

No person may sell live brown bullhead catfish.

Regulation 52A: inserted, on 1 April 2007, by regulation 6 of the Fisheries (Commercial Fishing) Amendment Regulations 2007 (SR 2007/32).

Shark finning

Heading: inserted, on 1 October 2014, by regulation 5 of the Fisheries (Commercial Fishing) Amendment Regulations (No 2) 2014 (LI 2014/279).

52B Shark finning prohibited

- (1) Commercial fishers must not undertake shark finning in New Zealand fisheries waters.

- (2) Commercial fishers must not land the fins of any species of shark unless the fins are landed naturally attached.
- (3) Despite subclause (2), commercial fishers may—
- (a) land any species of shark approved by the chief executive as being able to be landed with its fins artificially attached;
 - (b) land any species of shark approved by the chief executive as being able to be landed with its fins separate from its body if the ratio of the weight of the landed fins to the greenweight of the shark does not exceed the ratio approved by the chief executive.
- (4) If subclause (3)(b) applies, the fins must—
- (a) be stored in separate receptacles according to species; and
 - (b) be landed wet.

Regulation 52B: inserted, on 1 October 2014, by regulation 5 of the Fisheries (Commercial Fishing) Amendment Regulations (No 2) 2014 (LI 2014/279).

Regulation 52B(3)(a): replaced, on 6 October 2023, by regulation 75 of the Fisheries Amendment Regulations 2023 (SL 2023/243).

52C Circulars relating to shark finning

- (1) The chief executive may issue, amend, or revoke a circular that—
- (a) specifies the species of shark for which—
 - (i) fins may be landed separately from the body of the shark; or
 - (ii) fins may be landed artificially attached to the body of the shark; and
 - (b) for a circular issued under paragraph (a)(i),—
 - (i) sets the fin to greenweight ratio for the landing of fins and bodies for each species of shark; and
 - (ii) specifies the primary fins associated with each species of shark.
- (2) Before issuing, amending, or revoking a circular, the chief executive must consult, to the extent that is practicable in the circumstances, with any persons or organisations considered by the chief executive to be representative of the classes of persons or organisations likely to have an interest in the circular.
- (3) A circular issued under subclause (1) is secondary legislation (*see* Part 3 of the Legislation Act 2019 for publication requirements).

Legislation Act 2019 requirements for secondary legislation made under this regulation

Publication	The maker must publish it in the <i>Gazette</i>	LA19 ss 73, 74(1)(a), Sch 1 cl 14
Presentation	It is not required to be presented to the House of Representatives because a transitional exemption applies under Schedule 1 of the Legislation Act 2019	LA19 s 114, Sch 1 cl 32(1)(a)
Disallowance	It may be disallowed by the House of Representatives	LA19 ss 115, 116

This note is not part of the secondary legislation.

Regulation 52C: inserted, on 1 October 2014, by regulation 5 of the Fisheries (Commercial Fishing) Amendment Regulations (No 2) 2014 (LI 2014/279).

Regulation 52C(1): replaced, on 6 October 2023, by regulation 76 of the Fisheries Amendment Regulations 2023 (SL 2023/243).

Regulation 52C(3): inserted, on 28 October 2021, by regulation 29(2) of the Legislation Act (Sub-delegated Secondary Legislation) Regulations 2021 (LI 2021/248).

Part 3A

Fishing-related mortality limit of Hector's and Māui Dolphin in defined area

[Revoked]

Part 3A: revoked, on 30 December 2022, by regulation 7 of the Fisheries (Hector's and Māui Dolphin) Amendment Regulations 2022 (SL 2022/314).

52D Māui Dolphin habitat zone

[Revoked]

Regulation 52D: revoked, on 30 December 2022, by regulation 7 of the Fisheries (Hector's and Māui Dolphin) Amendment Regulations 2022 (SL 2022/314).

52E Fishing-related mortality limit for Hector's or Māui Dolphin within Māui Dolphin habitat zone

[Revoked]

Regulation 52E: revoked, on 30 December 2022, by regulation 7 of the Fisheries (Hector's and Māui Dolphin) Amendment Regulations 2022 (SL 2022/314).

Part 4

Conditions, restrictions, and prohibitions relating to fishing equipment

Part 4 heading: amended, on 1 October 2020, by regulation 35 of the Fisheries (Hector's and Māui Dolphin) Amendment Regulations 2020 (LI 2020/199).

Labelling of fish containers

Heading: amended, on 1 October 2008, by regulation 4 of the Fisheries (Commercial Fishing) Amendment Regulations (No 2) 2008 (SR 2008/272).

53 Labelling of containers

- (1) The operator, notified user, or master of a New Zealand fishing vessel must ensure that all cockles, kina, mussels, octopuses, oysters, paddle crabs, paua, pipi, scallops, tuatua, rock lobsters, or rock lobster tails landed from the vessel or transferred from the vessel to another vessel are held in containers that are clearly and legibly labelled on the outside with—
 - (a) the name and registered number of the fishing vessel from which the shellfish were taken; and
 - (b) the date on which the shellfish were taken; and

- (c) except in the case of rock lobsters, the area from which the shellfish were taken; and
 - (d) the signature of the operator, notified user, or master of the vessel from which the shellfish were taken; and
 - (e) the client name and number of the permit holder under whose permit the shellfish were taken.
- (2) A fishing permit holder who operates otherwise than from a registered fishing vessel must ensure that all cockles, kina, mussels, octopuses, oysters, paddle crabs, paua, pipi, scallops, tuatua, rock lobsters, or rock lobster tails that are taken are held in containers that are labelled on the outside with—
- (a) the permit holder's initials and surname; and
 - (b) the permit holder's fishing permit number; and
 - (c) the date on which the shellfish were taken; and
 - (d) except in the case of rock lobsters, the area from which the shellfish were taken; and
 - (e) the permit holder's signature.
- (2A) A commercial fisher must ensure that all eels that are taken are held in containers that are clearly and legibly labelled on the outside with the initials, surname, and client number of the permit holder under whose permit the eels were taken.
- (3) If subclause (1), (2), or (2A) applies, no person may—
- (a) possess containers that are unlabelled, partly labelled, or incorrectly labelled; or
 - (b) deliver to a person, sell, or otherwise dispose of, receive, or accept containers that are unlabelled, partly labelled, or incorrectly labelled; or
 - (c) remove the labels from the containers before the processing of the contents is commenced.

Compare: SR 1986/215 r 32

Regulation 53(2A): inserted, on 1 October 2008, by regulation 5(1) of the Fisheries (Commercial Fishing) Amendment Regulations (No 2) 2008 (SR 2008/272).

Regulation 53(3): amended, on 1 October 2008, by regulation 5(2) of the Fisheries (Commercial Fishing) Amendment Regulations (No 2) 2008 (SR 2008/272).

Marking of fishing gear

54 Longlines, static fishing gear, and set nets

- (1) Commercial fishers must not use for fishing, or have on board a fishing vessel, longlines, set nets, pots attached to a backbone, or other static fishing gear without surface floats at each end.

- (2) Each surface float must be clearly, permanently, and legibly marked with the registration number of the fishing vessel from which it was or will be set, or is being transported.
- (3) Despite subclause (1), trot lines, droplines, and dahn lines may be marked at one end only.
- (4) This regulation does not apply to fyke nets.

Compare: SR 1986/215 r 33

Regulation 54(1): amended, on 6 October 2023, by regulation 77(1) of the Fisheries Amendment Regulations 2023 (SL 2023/243).

Regulation 54(4): inserted, on 6 October 2023, by regulation 77(2) of the Fisheries Amendment Regulations 2023 (SL 2023/243).

55 Fyke nets

Commercial fishers must not use for fishing, or have on board a fishing vessel, a fyke net unless a surface float is securely attached that is clearly, permanently, and legibly marked with the registration number of the vessel from which it is set or transported.

Regulation 55: replaced, on 6 October 2023, by regulation 78 of the Fisheries Amendment Regulations 2023 (SL 2023/243).

56 Pots

- (1) Commercial fishers must not use for fishing, or have on board a fishing vessel, pots (including holding pots) without their own surface buoys or floats.
- (2) Each pot and surface buoy or float must be clearly, permanently, and legibly marked with the registration number of the vessel from which it is set or transported.
- (3) This regulation does not apply to pots attached to a backbone.

Regulation 56: substituted, on 1 June 2009, by regulation 6 of the Fisheries (Commercial Fishing) Amendment Regulations 2009 (SR 2009/94).

Regulation 56(3): inserted, on 6 October 2023, by regulation 79 of the Fisheries Amendment Regulations 2023 (SL 2023/243).

57 Gear not associated with vessel must be marked

If commercial fishers use gear covered by regulations 54 to 56, other than in conjunction with a fishing vessel, the gear must be marked as required under regulations 54 to 56, but with the permit number of the commercial fisher using the gear.

Compare: SR 1986/215 r 36

Seabird scaring devices

58 Seabird scaring devices required for tuna longlining

- (1) Commercial fishers taking tuna by using longlines from a vessel must ensure that, for the purpose of avoiding or mitigating the effect of fishing-related seabird mortality,—
 - (a) seabird scaring devices approved by the chief executive are carried on a vessel whenever the vessel is being used to take tuna by longline fishing; and
 - (b) seabird scaring devices are used in accordance with specifications (if any) issued by the chief executive.
- (2) Commercial fishers must permit inspection of seabird scaring devices at any reasonable time by a fishery officer or an observer appointed under section 223(2) of the Act.

Compare: SR 1986/215 r 36A

Regulation 58(1): amended, on 1 October 2009, by regulation 5 of the Fisheries (Commercial Fishing) Amendment Regulations (No 2) 2009 (SR 2009/243).

Avoidance or mitigation of fishing-related seabird mortality

Heading: inserted, on 1 October 2009, by regulation 6 of the Fisheries (Commercial Fishing) Amendment Regulations (No 2) 2009 (SR 2009/243).

58A Circulars may authorise or require seabird mitigation measures

- (1) The chief executive may issue, amend, or revoke a circular—
 - (a) authorising or requiring a particular seabird mitigation measure to be carried, used, or adopted (as the case may require) in relation to any specified vessel or class of vessel, if that measure is reasonably necessary to avoid or mitigate the effect of fishing-related seabird mortality;
 - (b) specifying the standards and requirements (if any) applying in respect of any seabird mitigation measure authorised or required under paragraph (a).
- (2) Before issuing, amending, or revoking a circular the chief executive must consult, to the extent that is practicable in the circumstances, with any persons or organisations that the chief executive considers to be representative of the classes of persons or organisations likely to be substantially affected by the circular.
- (3) A circular may specify different standards and requirements in respect of different types of seabird mitigation measure, including, in relation to any specified vessel or class of vessel,—
 - (a) a specified fishing practice or method;
 - (b) a specified fishery or area.

- (4) A circular issued under subclause (1) is secondary legislation (*see* Part 3 of the Legislation Act 2019 for publication requirements).

Legislation Act 2019 requirements for secondary legislation made under this regulation

Publication The maker must publish it in the *Gazette* LA19 ss 73, 74(1)(a),
Sch 1 cl 14

Presentation It is not required to be presented to the House of Representatives because a transitional exemption applies under Schedule 1 of the Legislation Act 2019 LA19 s 114, Sch 1
cl 32(1)(a)

Disallowance It may be disallowed by the House of Representatives LA19 ss 115, 116

This note is not part of the secondary legislation.

Regulation 58A: substituted, on 1 October 2009, by regulation 6 of the Fisheries (Commercial Fishing) Amendment Regulations (No 2) 2009 (SR 2009/243).

Regulation 58A(1): amended, on 28 October 2021, by regulation 30(1) of the Legislation Act (Sub-delegated Secondary Legislation) Regulations 2021 (LI 2021/248).

Regulation 58A(4): inserted, on 28 October 2021, by regulation 30(2) of the Legislation Act (Sub-delegated Secondary Legislation) Regulations 2021 (LI 2021/248).

58B Responsibility for compliance

- (1) The operator or master of a vessel to which this regulation applies must comply with any seabird mitigation measure authorised or required by any circular issued under regulation 58A(1)(a).
- (2) The operator or master must also ensure that a seabird mitigation measure—
- (a) complies with any standards and requirements specified under regulation 58A(1)(b); and
 - (b) is carried, used, or adopted (as the case may require) in accordance with those standards and requirements.
- (3) The operator or master must permit a fishery officer or observer to inspect at any reasonable time any seabird mitigation measure that is authorised or required by circular to be carried, used, or adopted (as the case may require) in relation to that vessel.

Regulation 58B: substituted, on 1 October 2009, by regulation 6 of the Fisheries (Commercial Fishing) Amendment Regulations (No 2) 2009 (SR 2009/243).

Avoidance or mitigation of fishing-related sea lion mortality

Heading: inserted, on 5 January 2022, by regulation 4 of the Commercial Fishing (Sea Lion Exclusion Device) Amendment Regulations 2021 (SL 2021/398).

58C Sea lion exclusion devices for commercial fishing in quota management area SQU6T

- (1) For the purpose of avoiding or mitigating the fishing-related mortality of sea lions, a commercial fisher using trawl nets to catch arrow squid in quota management area SQU6T must ensure that a sea lion exclusion device is used in each trawl net.

- (2) Every sea lion exclusion device must meet the specifications set out in a circular issued under regulation 58CA.

Regulation 58C: inserted, on 5 January 2022, by regulation 4 of the Commercial Fishing (Sea Lion Exclusion Device) Amendment Regulations 2021 (SL 2021/398).

58CA Circular may authorise specifications for sea lion exclusion devices

- (1) The chief executive may issue, amend, or revoke a circular that sets out—
- (a) the technical specifications that apply in respect of the device required by regulation 58C; and
 - (b) how the device must be used.
- (2) A circular issued under this regulation is secondary legislation (*see* Part 3 of the Legislation Act 2019 for publication requirements).

Legislation Act 2019 requirements for secondary legislation made under this regulation

Publication	The maker must publish it in accordance with the Legislation (Publication) Regulations 2021	LA19 s 74(1)(aa)
Presentation	The Minister must present it to the House of Representatives	LA19 s 114
Disallowance	It may be disallowed by the House of Representatives	LA19 ss 115, 116

This note is not part of the secondary legislation.

Regulation 58CA: inserted, on 5 January 2022, by regulation 4 of the Commercial Fishing (Sea Lion Exclusion Device) Amendment Regulations 2021 (SL 2021/398).

58C Responsibilities of vessel operator or master in relation to seabird scaring devices

[Revoked]

Regulation 58C: revoked, on 1 October 2009, by regulation 6 of the Fisheries (Commercial Fishing) Amendment Regulations (No 2) 2009 (SR 2009/243).

General provisions relating to nets

58D Use of drift nets prohibited

- (1) A commercial fisher must not use a drift net for fishing in New Zealand fisheries waters.
- (2) In this regulation, **drift net** means a net that—
- (a) acts by enmeshing, entrapping, or entangling any fish or aquatic life; and
 - (b) acts by drifting in the water or on the surface of the water in a manner primarily determined by the natural flow of the water or current; and
 - (c) is not attached to—
 - (i) any point of land; or
 - (ii) the seabed or riverbed.

Regulation 58D: inserted, on 1 October 2020, by regulation 36 of the Fisheries (Hector's and Māui Dolphin) Amendment Regulations 2020 (LI 2020/199).

59 Measurement of net mesh size

A certified gauge used for measuring the net mesh size must—

- (a) have the configuration of 1 or more of the gauges depicted in Part 1 of Schedule 3; and
- (b) bear an identifying mark and the letters “DSIR”, “MAF” or a Ministry mark, and a number, as recorded in the report referred to in paragraph (c); and
- (c) be certified as an accurate net mesh measuring gauge for the purposes of these regulations by reference to the mark and number recorded in a report issued—
 - (i) by the Measurements Standards Laboratory of New Zealand (as defined in the National Standards Regulations 1976); or
 - (ii) by an inspector or an accredited person (as those terms are defined in section 2 of the Weights and Measures Act 1987).

Compare: SR 1986/215 r 37

60 Restrictions on nets in channels

- (1) Commercial fishers must not use or set nets that, either by themselves or together with, or in conjunction with, another net, wing, leader, or other item attached to the net, extend more than one-quarter of the way across the width of a channel, river, or stream.
- (2) Commercial fishers must not use nets that, either by themselves or together with, or in conjunction with, another net, wing, leader, or other item attached to the net, extend more than one-quarter of the width of an arm of the sea, including an estuary, inlet, bay, or sound.
- (3) For the purposes of subclause (1), the width of a channel, river, or stream is the distance between the bank of the channel, river, or stream, measured at right angles at that place and at that time.
- (4) For the purposes of subclause (2), **width of an arm of the sea**—
 - (a) means the shortest line of any straight lines that may be drawn between any point on the water’s edge and any point on the opposing water’s edge, being a line that at some point intersects the net, or a wing, leader, or other item attached to the net; and
 - (b) includes an estuary, inlet, bay, or sound.

Compare: SR 1986/215 r 38

Regulation 60(4): replaced, on 6 October 2023, by regulation 80 of the Fisheries Amendment Regulations 2023 (SL 2023/243).

61 Stalling prohibited

Commercial fishers must not set nets so that stalling occurs and must ensure that stalling does not occur while the nets are set.

Compare: SR 1986/215 r 39

62 Use of poles or stakes

Commercial fishers must not erect poles or stakes for use with fishing nets, or use them in conjunction with fishing nets, except if the poles or stakes—

- (a) are used in conjunction with fyke nets; and
- (b) are clearly visible at all stages of the tide; and
- (c) are removed when fishing stops.

Compare: SR 1986/215 r 40

63 Use of specified nets prohibited

- (1) Commercial fishers must not use Danish seine nets, trawl nets, box or teichi nets, trammel nets, purse seine nets, or lampara nets in rivers, streams, lakes, lagoons, or estuaries.
- (2) Commercial fishers must not set, use, or possess baited nets other than ring pots, fyke nets, hoop nets, or pullpots.
- (3) Commercial fishers must not use or possess trammel nets.

Compare: SR 1986/215 r 41

Regulation 63(2): amended, on 2 October 2003, by regulation 3 of the Fisheries (Commercial Fishing) Amendment Regulations (No 2) 2003 (SR 2003/222).

64 Use of net-sonde monitor cables prohibited

Commercial fishers must not operate net-sonde monitor cables from New Zealand fishing vessels or foreign-owned New Zealand fishing vessels.

Compare: SR 1986/215 r 41A

Set nets

65 Length of set net

- (1) Commercial fishers must not use set nets or a combination of set nets if the total length of a net or a combination of nets, whether attached together or otherwise, is more than 1 000 m.
- (2) Subclause (1) does not apply if all of the upper edge of each set net is more than 2 m below the surface of the water.
- (3) Commercial fishers must not use set nets or a combination of set nets in New Zealand fisheries waters if the total length of a net or a combination of nets, whether attached together or otherwise, is more than 3 000 m.
- (4) Subclause (3) does not apply if the chief executive authorises the use of the net or nets under subclause (5).

- (5) The chief executive may, in writing, authorise a commercial fisher to use a set net or a combination of set nets in New Zealand fisheries waters, whether attached together or not, with a total length of not more than 6 000 m.
- (6) In subclauses (3) and (5), **New Zealand fisheries waters** does not include a river, stream, lake, lagoon, or estuary.
- (7) Before issuing an authorisation under subclause (5), the chief executive must be satisfied that the commercial fisher has previously used a set net or a combination of set nets, whether attached together or otherwise, whose total length was not less than 3 000 m.
- (8) *[Revoked]*
- (9) Commercial fishers must not, in rivers, streams, lakes, lagoons, or estuaries,—
 - (a) use set nets or a combination of set nets if the total length of a net or a combination of nets, whether attached together or otherwise, exceeds 1 000 m; or
 - (b) set a set net within 60 m of another set net.

Compare: SR 1986/215 r 42

Regulation 65(8): revoked, on 6 October 2023, by regulation 81 of the Fisheries Amendment Regulations 2023 (SL 2023/243).

66 Set net soak time

Commercial fishers must not leave set nets in the water for more than 18 hours without under-running the net and removing fish that have been caught.

Compare: SR 1986/215 r 42A

Drag nets and beach seine nets

67 Length of drag net or beach seine net

- (1) Commercial fishers must not use or have drag nets or beach seine nets that are longer than 165 m.
- (2) In this regulation, **drag net** and **beach seine net** do not include a warp, rope, or chain attached to the net.

Compare: SR 1986/215 r 43

68 Method of hauling drag net or beach seine net

Commercial fishers must not use beach seine nets or drag nets unless the nets are pulled or hauled by hand, without the aid of a pulley, other mechanical device, or vessel.

Compare: SR 1986/215 r 44

Danish seine nets

69 Danish seine net restrictions

- (1) Commercial fishers must not use for fishing, or have on board a fishing vessel, Danish seine nets.
- (2) Subclause (1) applies only if the mesh of the net—
 - (a) is less than 125 mm in the cod-end; or
 - (b) has more than 1 layer of mesh; or
 - (c) has liners, sleeves, or flappers of any material; or
 - (d) has a method of strengthening with centres less than 1 m.
- (3) In this regulation, **liner** means any material that is attached to any part of the inside of a Danish seine net in a way that means it acts to reduce the ability of fish to escape the net.

Compare: SR 1986/215 r 45

Regulation 69(2)(d): amended, on 6 October 2023, by regulation 82(1) of the Fisheries Amendment Regulations 2023 (SL 2023/243).

Regulation 69(3): inserted, on 6 October 2023, by regulation 82(2) of the Fisheries Amendment Regulations 2023 (SL 2023/243).

70 Danish seining prohibited near South Island coast

Commercial fishers must not use Danish seine nets within 3 nautical miles seaward of the mean high-water mark of the coast of the South Island.

Compare: SR 1986/215 r 46

Trawl nets

71 Trawl net restrictions

- (1) A commercial fisher must not use for fishing, or have on board a fishing vessel, a trawl net if,—
 - (a) in the case of a trawl net that includes mesh, the trawl net has any 1 or more of the following features:
 - (i) more than 1 layer of mesh:
 - (ii) liners, sleeves, or flappers of any material:
 - (iii) a method of strengthening with centres less than 1 m:
 - (iv) net mesh size less than 100 mm unless a fishing permit authorises the use or possession of the mesh:
 - (b) in any other case, the chief executive has not approved the trawl net for use under regulation 71A.
- (2) Subclause (1)(a) does not prohibit a commercial fisher from using for fishing or possessing on a vessel a trawl net that has been approved for use under regulation 71A.

- (3) Subclause (1) does not prohibit the use of chafer gear on the underside of a trawl net if the after end of the chafer or chafing gear—
 - (a) is, and remains, detached from the trawl net; and
 - (b) is attached in a manner that will readily allow the escape of small fish through the mesh of the cod-end.
- (4) Subclause (1) does not prohibit a commercial fisher from having trawl nets on a vessel if—
 - (a) the nets may lawfully be used by the commercial fisher from that vessel in another area of New Zealand fisheries waters; and
 - (b) the vessel is to be used or has been used on that voyage to fish in that area.
- (5) Subclause (1) does not prohibit a commercial fisher from using for fishing or possessing on a vessel trawl nets with a mesh not less than 80 mm in the body of the net, and not less than 55 mm in the cod-end of the net, if the fisher—
 - (a) is fishing for or intends to fish for scampi or prawn killer; and
 - (b) has notified the chief executive in writing of the fisher's intention to fish for scampi or prawn killer in that fishing year.
- (6) In this regulation, **liner** means any material that is attached to any part of the inside of a trawl net in a way that means it acts to reduce the ability of fish to escape the net.

Compare: SR 1986/215 r 47

Regulation 71(1): replaced, on 1 October 2017, by regulation 6 of the Fisheries (Trawling) Amendment Regulations 2017 (LI 2017/157).

Regulation 71(2): replaced, on 1 October 2017, by regulation 6 of the Fisheries (Trawling) Amendment Regulations 2017 (LI 2017/157).

Regulation 71(5): added, on 1 October 2004, by regulation 3 of the Fisheries (Commercial Fishing) Amendment Regulations (No 3) 2004 (SR 2004/329).

Regulation 71(5)(a): amended, on 1 October 2007, by regulation 5 of the Fisheries (Commercial Fishing) Amendment Regulations (No 2) 2007 (SR 2007/252).

Regulation 71(5)(b): amended, on 1 October 2007, by regulation 5 of the Fisheries (Commercial Fishing) Amendment Regulations (No 2) 2007 (SR 2007/252).

Regulation 71(6): inserted, on 6 October 2023, by regulation 83 of the Fisheries Amendment Regulations 2023 (SL 2023/243).

71A Approval of trawl nets

- (1) The chief executive may, on application by any person, approve the use of a trawl net (**A**) if the chief executive is satisfied that—
 - (a) A performs at least as well as a specified net in providing for the utilisation of fisheries resources while ensuring sustainability (*see* regulation 71B); and
 - (b) the use of A is consistent with relevant fisheries plans approved under section 11A of the Act.

- (2) In this regulation and regulation 71B, **specified net**, in relation to an application for a net that is proposed to be used for taking 1 or more particular species in 1 or more areas, means a trawl net that,—
- (a) at the time of the application, may be used for fishing under regulation 71 or under other regulations in force under the Act that relate to commercial fishing in a specified area of New Zealand fisheries waters; and
 - (b) the chief executive otherwise considers is appropriate to use for the comparison under subclause (1), having regard to the kinds of net that are commonly used, or are approved for use under this regulation, for taking at least 1 of those species in at least 1 of those areas or in a similar area.
- (3) The approval—
- (a) must be notified on an Internet site maintained by or on behalf of the Ministry; and
 - (b) may be given on the terms and conditions that the chief executive thinks fit (for example, relating to the areas in which the net may be used and the species that may be targeted); and
 - (c) *[Revoked]*
- (4) The terms and conditions of an approval may be varied by the chief executive—
- (a) on the application of the person who applied for the approval; or
 - (b) at the chief executive's own initiative if satisfied that the variation is necessary to address a risk to ensuring sustainability that was not known at the time the approval was first given.
- (5) A variation of the terms and conditions of an approval—
- (a) must be notified on an Internet site maintained by or on behalf of the Ministry; and
 - (b) takes effect 28 days after it is notified.
- (6) A person who uses a trawl net that has been approved under this regulation must comply with the terms and conditions of its approval (as varied from time to time).
- (7) *[Revoked]*
- (8) See clause 13A of Schedule 2 for the fee that must be paid in relation to an application.

Regulation 71A: inserted, on 1 October 2017, by regulation 7 of the Fisheries (Trawling) Amendment Regulations 2017 (LI 2017/157).

Regulation 71A(3)(c): revoked, on 10 January 2019, by regulation 4(1) of the Fisheries (Commercial Fishing) Amendment Regulations 2018 (LI 2018/261).

Regulation 71A(4): replaced, on 10 January 2019, by regulation 4(2) of the Fisheries (Commercial Fishing) Amendment Regulations 2018 (LI 2018/261).

Regulation 71A(5): replaced, on 10 January 2019, by regulation 4(2) of the Fisheries (Commercial Fishing) Amendment Regulations 2018 (LI 2018/261).

Regulation 71A(6): inserted, on 10 January 2019, by regulation 4(2) of the Fisheries (Commercial Fishing) Amendment Regulations 2018 (LI 2018/261).

Regulation 71A(7): revoked, on 6 October 2023, by regulation 84 of the Fisheries Amendment Regulations 2023 (SL 2023/243).

Regulation 71A(8): inserted, on 10 January 2019, by regulation 4(2) of the Fisheries (Commercial Fishing) Amendment Regulations 2018 (LI 2018/261).

71B Consideration of application for approval

(1) This regulation applies when the chief executive is comparing the performance of the trawl net that is the subject of the application (**A**) with that of a specified net (**B**) under regulation 71A.

(2) The comparison must be made by assessing the following matters:

Species composition

(a) how A compares (or is likely to compare) with B with respect to the relative species composition (including both quota management system and non-quota management system species):

Size composition

(b) how A compares (or is likely to compare) with B with respect to the relative size composition (including both quota management system and non-quota management system species):

Impact on protected species

(c) how the number of protected species injured or killed by A compares (or is likely to compare) with the number of protected species injured or killed by B:

Impact on benthic species

(d) how the weight of benthic species, or the area of seabed, impacted by A compares (or is likely to compare) with the weight of benthic species, or the area of seabed, impacted by B.

(3) The comparison may also include assessing any other matter that the chief executive considers relevant, including—

(a) matters relating to ensuring sustainability other than those described in subclause (2); and

(b) matters relating to utilisation (for example, the value of the catch).

Regulation 71B: inserted, on 1 October 2017, by regulation 7 of the Fisheries (Trawling) Amendment Regulations 2017 (LI 2017/157).

71C Notices relating to approval of trawl net

(1) The chief executive may issue, amend, or revoke a notice that specifies technical details relating to—

- (a) the manner in which a comparison must be made under regulation 71B, including—
- (i) matters that the chief executive must have regard to when deciding whether information from trials is required:
 - (ii) what information from trials is required (if any):
- (b) information that must be included in an application under regulation 71A(1) or (4).
- (2) Before issuing, amending, or revoking a notice, the chief executive must consult, to the extent practicable, any persons considered by the chief executive to be representative of the classes of persons likely to be substantially affected by the notice.
- (3) The following are secondary legislation (*see* Part 3 of the Legislation Act 2019 for publication requirements):
- (a) a notice issued under subclause (1):
 - (b) an amendment or a revocation of a notice.

Legislation Act 2019 requirements for secondary legislation made under this regulation

Publication	The maker must: <ul style="list-style-type: none">• publish it on a website maintained by, or on behalf of, the maker• if a notice is amended, publish an up to date version of it as amended	LA19 ss 73, 74(1)(a), Sch 1 cl 14
Presentation	It is not required to be presented to the House of Representatives because a transitional exemption applies under Schedule 1 of the Legislation Act 2019	LA19 s 114, Sch 1 cl 32(1)(a)
Disallowance	It may be disallowed by the House of Representatives	LA19 ss 115, 116

This note is not part of the secondary legislation.

Regulation 71C: inserted, on 1 October 2017, by regulation 7 of the Fisheries (Trawling) Amendment Regulations 2017 (LI 2017/157).

Regulation 71C(3): replaced, on 28 October 2021, by regulation 31 of the Legislation Act (Sub-delegated Secondary Legislation) Regulations 2021 (LI 2021/248).

72 Trawling by vessels over 46 m long prohibited in territorial sea

Commercial fishers must not use New Zealand fishing vessels or foreign-owned New Zealand fishing vessels over 46 m in overall length for trawling in the territorial sea.

Compare: SR 1986/215 r 47A

73 Trawling prohibited in closed seamount areas

- (1) No person may use a trawl net for fishing in a closed seamount area.
- (2) In this regulation, **closed seamount area** means all waters within an area identified by regulations as a seamount area in which fishing by use of a trawl net is prohibited.

Compare: SR 1986/215 r 47B

74 Other methods of fishing prohibited

[Revoked]

Regulation 74: revoked, on 12 May 2011, by clause 3 of the Fisheries Regulations Revocation Order 2011 (SR 2011/96).

Fyke nets

75 Tubes must be incorporated in fyke nets

Commercial fishers must not use fyke nets unless—

- (a) 2 escapement tubes are incorporated between the last trap or throat and the last part of each net that is capable of holding finfish while in the water; and
- (b) the escapement tubes are—
 - (i) not less than 31 mm in inside diameter (except that the inside diameter of both ends of the tube must be at least 32 mm); and
 - (ii) not less than 35 mm in length; and
 - (iii) placed so as to project inside the net not more than 10 mm.

Compare: SR 1986/215 r 49

Regulation 75: amended, on 1 October 2013, by regulation 5(1) of the Fisheries (Commercial Fishing) Amendment Regulations 2013 (SR 2013/325).

Regulation 75(b)(i): amended, on 1 October 2013, by regulation 5(2) of the Fisheries (Commercial Fishing) Amendment Regulations 2013 (SR 2013/325).

Regulation 75(b)(i): amended, on 1 October 2013, by regulation 5(3) of the Fisheries (Commercial Fishing) Amendment Regulations 2013 (SR 2013/325).

Underwater breathing apparatus

76 Restrictions relating to underwater breathing apparatus

Except as provided in regulations 76A and 77, commercial fishers must not—

- (a) use or have underwater breathing apparatus when taking fish, aquatic life, or seaweed; or
- (b) have underwater breathing apparatus while in possession of fish, aquatic life, or seaweed; or
- (c) have underwater breathing apparatus on board New Zealand fishing vessels or foreign-owned New Zealand fishing vessels.

Compare: SR 1986/215 r 51

Regulation 76: amended, on 1 October 2006, by regulation 5 of the Fisheries (Commercial Fishing) Amendment Regulations (No 2) 2006 (SR 2006/235).

76A Underwater breathing apparatus allowed when taking certain species

- (1) This subclause applies to—
 - (a) deepwater clam:

- (b) horse mussel:
 - (c) sea cucumber:
 - (d) kina, if taken from quota management area SUR4:
 - (e) paua, if taken from quota management area PAU4.
- (2) If a commercial fisher is using a New Zealand fishing vessel for fishing for any of the species to which subclause (1) applies (the **specified species**), the commercial fisher may—
- (a) use or have underwater breathing apparatus when taking the specified species:
 - (b) have underwater breathing apparatus when in possession of the specified species:
 - (c) have underwater breathing apparatus on board the vessel for the purpose of taking the specified species.
- (3) Nothing in subclause (2) allows a commercial fisher—
- (a) to use or have underwater breathing apparatus when taking fish, aquatic life, or seaweed other than the specified species; or
 - (b) to have underwater breathing apparatus on board a vessel from which fish, aquatic life, or seaweed, other than the specified species, is taken.
- (4) In this regulation,—

horse mussel means a shellfish of the species *Atrina zelandica*

quota management area PAU4 has the meaning set out in Part 3 of Schedule 1 of the Act

quota management area SUR4 means the area defined as fishery management area 4—South East (Chatham Rise) in Part 1 of Schedule 1 of the Act

sea cucumber means a holothurian of the species *Stichopus mollis*.

Regulation 76A: replaced, on 1 October 2013, by regulation 6 of the Fisheries (Commercial Fishing) Amendment Regulations 2013 (SR 2013/325).

Regulation 76A(2): amended, on 1 October 2017, by regulation 13 of the Fisheries (Geospatial Position Reporting) Regulations 2017 (LI 2017/155).

77 Underwater breathing apparatus allowed in certain circumstances

- (1) Underwater breathing apparatus may be carried on board and used from a New Zealand fishing vessel if the underwater breathing apparatus is sealed on the fishing vessel by a fishery officer and only carried or used—
- (a) to retrieve lost fishing gear that cannot effectively be recovered by another means; or
 - (b) for emergencies involving the preservation of life or the safety of the vessel or other vessels.
- (2) If underwater breathing apparatus has been used for a purpose specified in subclause (1), the operator, notified user, or master must,—

- (a) as soon as practicable, inform a fishery officer, by some form of communication from the vessel, of the circumstances involving the use of the apparatus; and
 - (b) not permit the vessel to put to sea again after entering a port or refuge until the apparatus has been resealed by, or under the direction of, a fishery officer.
- (3) Underwater breathing apparatus may be carried on board and used from a registered fishing vessel if—
- (a) the apparatus is not used for commercial fishing; and
 - (b) the chief executive authorises the apparatus to be carried and used; and
 - (c) it is carried and used in accordance with conditions specified by the chief executive.

Compare: SR 1986/215 r 52

Shellfish dredges

78 Shellfish dredge design and size

- (1) Commercial fishers who fish for shellfish other than surf clams must not use—
- (a) more than 1 dredge with a bar or bit that is more than 2.5 m long; or
 - (b) more than 2 dredges, either of which has a bar or bit that is more than 1.4 m long.
- (2) However, commercial fishers fishing for surf clams may use 1 or more dredges that have a bar or bit of any length.

Compare: SR 1986/215 r 53

Regulation 78(1): amended, on 1 April 2008, by regulation 7(1) of the Fisheries (Commercial Fishing) Amendment Regulations 2008 (SR 2008/26).

Regulation 78(2): added, on 1 April 2008, by regulation 7(2) of the Fisheries (Commercial Fishing) Amendment Regulations 2008 (SR 2008/26).

Pots

Heading: substituted, on 1 June 2009, by regulation 8 of the Fisheries (Commercial Fishing) Amendment Regulations 2009 (SR 2009/94).

79 Apertures required in rock lobster pots

- (1) Commercial fishers must not use or have rock lobster pots on board fishing vessels unless the pots have at least 2 rectangular apertures (other than the mouth) through which undersize rock lobsters are able to escape.
- (2) An escape aperture must not—
- (a) be included in either the top or the bottom of a pot; or
 - (b) have inside dimensions of less than 200 mm long and 54 mm wide.
- (3) Rock lobster pots that are required to have escape apertures must be constructed so that—

- (a) there are escape apertures in at least 2 opposite faces of the pots; and
 - (b) if the escape apertures are placed vertically, the total inside length of the escape aperture or apertures on 1 face of the pots is not less than 80% of the total height of the face of the pots on which the aperture or apertures are placed; and
 - (c) if the apertures are not placed vertically, the total inside length of the escape aperture or apertures on 1 face of the pots is not less than 80% of the total length of the face of the pots on which the aperture or apertures are placed.
- (4) Despite subclauses (1) and (3), commercial fishers must not use round rock lobster pots, or have them on board fishing vessels, unless—
- (a) the pots have at least 3 rectangular apertures (other than the mouth) through which undersize rock lobsters are able to escape; and
 - (b) each aperture has inside dimensions of not less than 200 mm long by 54 mm wide.
- (5) This regulation does not prohibit the use or possession of rock lobster pots without escape apertures on board fishing vessels if—
- (a) the pots are constructed entirely of spot welded rectangular mesh with inside dimensions of not less than 140 mm long by 54 mm wide; and
 - (b) the pots are used—
 - (i) without covers or liners; or
 - (ii) with covers or liners that leave unencumbered at least 80% of the surface area of each of 2 opposite sides.
- (6) This regulation does not prohibit the use of rock lobster pots for holding rock lobsters if the pots are not capable of being used for taking rock lobsters.
- (7) To avoid doubt, this regulation does not prohibit the use or possession of pots without apertures for taking species other than rock lobster.

Compare: SR 1986/215 r 54

Regulation 79(5): substituted, on 2 October 2003, by regulation 4 of the Fisheries (Commercial Fishing) Amendment Regulations (No 2) 2003 (SR 2003/222).

Regulation 79(7): added, on 1 June 2009, by regulation 9 of the Fisheries (Commercial Fishing) Amendment Regulations 2009 (SR 2009/94).

79A Requirements for pots used for taking blue cod or octopus

- (1) Commercial fishers must not use or have on board a fishing vessel any pot used to take blue cod unless—
- (a) the pot is covered with a single layer of ridged square mesh; and
 - (b) the mesh has inside dimensions of no less than 54 mm in width; and
 - (c) the pot does not have any cover, liner, or any other construction that restricts the inside dimensions of the mesh to less than 54 mm.

- (1A) *[Revoked]*
- (1B) *[Revoked]*
- (2) Commercial fishers must not use or have on board a fishing vessel any pot used to take octopus unless the entrance to the pot is covered and secured by a latch or similar device so that an octopus must force its way into the pot.
- (3) The requirements in subclauses (1) and (2) only apply when the specified species in that subclause is the target species.

Regulation 79A: inserted, on 1 June 2009, by regulation 10 of the Fisheries (Commercial Fishing) Amendment Regulations 2009 (SR 2009/94).

Regulation 79A(1): replaced, on 1 July 2020, by regulation 4(1) of the Fisheries (Commercial Fishing) Amendment Regulations 2020 (LI 2020/85).

Regulation 79A(1A): revoked, on 1 July 2020, by regulation 4(2) of the Fisheries (Commercial Fishing) Amendment Regulations 2020 (LI 2020/85).

Regulation 79A(1B): revoked, on 1 July 2020, by regulation 4(2) of the Fisheries (Commercial Fishing) Amendment Regulations 2020 (LI 2020/85).

Regulation 79A(3): inserted, on 6 October 2023, by regulation 85 of the Fisheries Amendment Regulations 2023 (SL 2023/243).

Spears

80 Use of spears prohibited

Commercial fishers must not use spears to take fish and must not possess fish that have been speared.

Compare: SR 1986/215 r 55

Wire traces and shark lines

Heading: inserted, on 20 December 2015, by regulation 7 of the Fisheries (Commercial Fishing) Amendment Regulations 2015 (LI 2015/268).

80A Use of wire traces and shark lines by commercial tuna and billfish fishers prohibited

- (1) Commercial fishers who fish for tuna or billfish must not fish using wire traces or have wire traces on board the fishing vessel.
- (2) Commercial fishers who fish for tuna or billfish must not fish using shark lines.

Regulation 80A: inserted, on 20 December 2015, by regulation 7 of the Fisheries (Commercial Fishing) Amendment Regulations 2015 (LI 2015/268).

Surface longlining hooks

Heading: inserted, on 3 August 2023, by regulation 5 of the Fisheries (Commercial Fishing) Amendment Regulations 2023 (SL 2023/171).

80B Use of circular or oval hooks required when surface longlining

Commercial fishers who are surface longlining in New Zealand fisheries waters must use a hook or hooks that—

- (a) are circular or oval in shape; and

- (b) have the point turned perpendicularly back to the shank; and
- (c) comply with the requirements set out in a circular (if any) issued under regulation 80C.

Regulation 80B: inserted, on 3 August 2023, by regulation 5 of the Fisheries (Commercial Fishing) Amendment Regulations 2023 (SL 2023/171).

80C Circulars relating to surface longlining hooks

- (1) The chief executive may issue, amend, or revoke a circular specifying the requirements relating to hooks that commercial fishers must comply with when surface longlining in New Zealand fisheries waters.
- (2) Before issuing, amending, or revoking a circular, the chief executive must consult, to the extent that is practicable in the circumstances, with any persons or organisations considered by the chief executive to be representative of the classes of persons or organisations likely to be substantially affected by the circular.
- (3) A circular issued under subclause (1) is secondary legislation (*see* Part 3 of the Legislation Act 2019 for publication requirements).

Legislation Act 2019 requirements for secondary legislation made under this regulation

Publication	The maker must publish it in accordance with the Legislation (Publication) Regulations 2021	LA19 s 74(1)(aa)
Presentation	The Minister must present it to the House of Representatives	LA19 s 114
Disallowance	It may be disallowed by the House of Representatives	LA19 ss 115, 116

This note is not part of the secondary legislation.

Regulation 80C: inserted, on 3 August 2023, by regulation 5 of the Fisheries (Commercial Fishing) Amendment Regulations 2023 (SL 2023/171).

Part 5

Authorised stocks

[Revoked]

Part 5: revoked, on 1 October 2004, by section 65(1) of the Fisheries Amendment Act (No 3) 2004 (2004 No 76).

81 Declaration of authorised stocks

[Revoked]

Regulation 81: revoked, on 1 October 2004, by section 65(1) of the Fisheries Amendment Act (No 3) 2004 (2004 No 76).

Part 5A

Alternative methods of disposal

Part 5A: inserted, on 5 October 2023, by regulation 4 of the Fisheries (Commercial Fishing) Amendment Regulations (No 2) 2023 (SL 2023/242).

81A Chief executive may approve alternative method of disposal

The chief executive may approve an alternative method of disposal for the purposes of section 191(1)(c) of the Act only after having taken into account the following matters:

- (a) whether there is a need for a method of disposal other than those specified in section 191(1)(a) and (b) of the Act;
- (b) the extent to which the proposed alternative method of disposal—
 - (i) provides a practical alternative to sale or disposal under section 191(1)(a) and (b) of the Act; and
 - (ii) is administratively simple and efficient to operate; and
 - (iii) is cost-effective for commercial fishers to use;
- (c) whether the proposed alternative method of disposal supports record-keeping, reporting, monitoring, and enforcement under the Act in respect of disposal of fish by commercial fishers.

Regulation 81A: inserted, on 5 October 2023, by regulation 4 of the Fisheries (Commercial Fishing) Amendment Regulations (No 2) 2023 (SL 2023/242).

81B Use of alternative method of disposal

- (1) A commercial fisher may dispose of fish using an alternative method of disposal only if—
 - (a) the alternative method of disposal is approved under regulation 81A; and
 - (b) they are approved under regulation 81C to do so; and
 - (c) they comply with any technical specifications set out in a circular issued under regulation 81D.
- (2) A commercial fisher may apply, in accordance with a circular issued under regulation 81D, to the chief executive for approval to use an alternative method of disposal approved under regulation 81A.

Regulation 81B: inserted, on 5 October 2023, by regulation 4 of the Fisheries (Commercial Fishing) Amendment Regulations (No 2) 2023 (SL 2023/242).

81C Chief executive may approve use of alternative method of disposal

- (1) The chief executive may approve a person to use an alternative method of disposal approved under regulation 81A if the chief executive is satisfied that the person—
 - (a) holds a fishing permit issued under section 91; and
 - (b) is not a licensed fish receiver.

- (2) The chief executive may revoke an approval issued under subclause (1) if the chief executive is satisfied that the holder no longer satisfies the requirements in subclause (1)(a) and (b).

Regulation 81C: inserted, on 5 October 2023, by regulation 4 of the Fisheries (Commercial Fishing) Amendment Regulations (No 2) 2023 (SL 2023/242).

81D Circulars in relation to alternative methods of disposal

- (1) The chief executive may issue, amend, or revoke a circular that does 1 or more of the following:
- (a) lists the alternative methods of disposal that have been approved under regulation 81A:
 - (b) sets out technical specifications relating to, or relating to the use of, an alternative method of disposal approved under regulation 81A:
 - (c) sets out an application process for the purposes of regulation 81B(2).
- (2) Before issuing, amending, or revoking a circular, the chief executive must consult, to the extent that is practicable in the circumstances, with any persons or organisations considered by the chief executive to be representative of the classes of persons or organisations likely to have an interest in the circular.
- (3) A circular issued under subclause (1) is secondary legislation (see Part 3 of the Legislation Act 2019 for publication requirements).

Legislation Act 2019 requirements for secondary legislation made under this regulation

Publication	The maker must publish it in accordance with the Legislation (Publication) Regulations 2021	LA19 s 74(1)(aa)
Presentation	The Minister must present it to the House of Representatives	LA19 s 114
Disallowance	It may be disallowed by the House of Representatives	LA19 ss 115, 116

This note is not part of the secondary legislation.

Regulation 81D: inserted, on 5 October 2023, by regulation 4 of the Fisheries (Commercial Fishing) Amendment Regulations (No 2) 2023 (SL 2023/242).

81E Chief executive to review approval of alternative method of disposal

- (1) If the chief executive approves an alternative method of disposal under regulation 81A, the chief executive must, within 5 years of the date of the approval, complete a review of that approval, taking into account—
- (a) the matters described in regulation 81A; and
 - (b) any other matters that the chief executive considers relevant.
- (2) The chief executive may revoke an approval of an alternative method of disposal if the chief executive is satisfied, after completing a review under subclause (1), that it is appropriate to do so.

Regulation 81E: inserted, on 5 October 2023, by regulation 4 of the Fisheries (Commercial Fishing) Amendment Regulations (No 2) 2023 (SL 2023/242).

Part 6

Fees, offences, and penalties

Fees

82 Fees

Fees must be paid as specified in Schedule 2.

Compare: SR 1986/215 r 56

83 Chief executive may waive or remit certain fees

- (1) The chief executive may waive or remit, in whole or in part, all fees payable under these regulations, if he or she considers that the waiver or remission is in the public interest.
- (2) An instrument waiving or remitting fees is secondary legislation (*see* Part 3 of the Legislation Act 2019 for publication requirements), unless it applies only to 1 or more named persons.

Compare: SR 1986/215 r 56A

Legislation Act 2019 requirements for secondary legislation made under this regulation

Publication	It is not required to be published	LA19 s 73(2)
Presentation	It is not required to be presented to the House of Representatives because a transitional exemption applies under Schedule 1 of the Legislation Act 2019	LA19 s 114, Sch 1 cl 32(1)(a)
Disallowance	It may be disallowed by the House of Representatives	LA19 ss 115, 116

This note is not part of the secondary legislation.

Regulation 83(2): inserted, on 28 October 2021, by regulation 32 of the Legislation Act (Sub-delegated Secondary Legislation) Regulations 2021 (LI 2021/248).

Offences

84 Offences

- (1) A person commits an offence who contravenes or fails to comply with regulation 6.
- (2) A person commits an offence who contravenes or fails to comply with regulations 5, 7, 8(1), 16(1) to (6), 17(4) to (6), 18, 19(3), (7), (8) or (10), 20(1), (3), (5) or (7), 21(1), 22, 25, 42(1) or (2), 43(1), (2) or (4), 52A, 53 to 57, 58B(2) or (3), 62, 71A(6), 76, 77, 80, 80A, or 80B.
- (3) A person commits an offence who contravenes or fails to comply with regulations 9, 10(2) or (3), 11 to 13, 14, 17(3) or (7) to (10), 19(2), (4) to (6) or (9), 23, 24(2), 27 to 29, 30(2) to (4), 31(1), (5) or (6), 32(1) to (3), 33(1) or (2), 34, 35, 36(1) or (2), 37(1) or (2), 41(2) or (3), 44(1) or (2), 45(1), 46 to 48, 50(1) or (2), 51(1) or (2), 52B, 58, 58B(1), 58C(1) and (2), 58D, 60, 61, 63, 64, 65(1), (3), or (9), 66, 67(1), 68, 69(1), 70, 71(1), 72, 73, 74, 75, 78, 79(1) to (4), 79A, or 81B(1)(a), (b), or (c).

Regulation 84(2): amended, on 3 August 2023, by regulation 6 of the Fisheries (Commercial Fishing) Amendment Regulations 2023 (SL 2023/171).

Regulation 84(2): amended, on 10 January 2019, by regulation 5 of the Fisheries (Commercial Fishing) Amendment Regulations 2018 (LI 2018/261).

Regulation 84(2): amended, on 20 December 2015, by regulation 8(1) of the Fisheries (Commercial Fishing) Amendment Regulations 2015 (LI 2015/268).

Regulation 84(2): amended, on 1 October 2013, by regulation 7 of the Fisheries (Commercial Fishing) Amendment Regulations 2013 (SR 2013/325).

Regulation 84(2): amended, on 1 October 2009, by regulation 7(1) of the Fisheries (Commercial Fishing) Amendment Regulations (No 2) 2009 (SR 2009/243).

Regulation 84(2): amended, on 1 June 2009, by regulation 11(1) of the Fisheries (Commercial Fishing) Amendment Regulations 2009 (SR 2009/94).

Regulation 84(2): amended, on 1 October 2008, by regulation 6(1) of the Fisheries (Commercial Fishing) Amendment Regulations (No 2) 2008 (SR 2008/272).

Regulation 84(2): amended, on 1 April 2007, by regulation 7 of the Fisheries (Commercial Fishing) Amendment Regulations 2007 (SR 2007/32).

Regulation 84(2): amended, on 1 October 2004, by regulation 7(a) of the Fisheries (Commercial Fishing) Amendment Regulations (No 2) 2004 (SR 2004/284).

Regulation 84(2): amended, on 1 October 2004, by regulation 7(b) of the Fisheries (Commercial Fishing) Amendment Regulations (No 2) 2004 (SR 2004/284).

Regulation 84(3): amended, on 6 October 2023, by regulation 86 of the Fisheries Amendment Regulations 2023 (SL 2023/243).

Regulation 84(3): amended, on 5 October 2023, by regulation 5 of the Fisheries (Commercial Fishing) Amendment Regulations (No 2) 2023 (SL 2023/242).

Regulation 84(3): amended, on 5 January 2022, by regulation 5 of the Commercial Fishing (Sea Lion Exclusion Device) Amendment Regulations 2021 (SL 2021/398).

Regulation 84(3): amended, on 1 October 2020, by regulation 37 of the Fisheries (Hector's and Māui Dolphin) Amendment Regulations 2020 (LI 2020/199).

Regulation 84(3): amended, on 20 December 2015, by regulation 8(2) of the Fisheries (Commercial Fishing) Amendment Regulations 2015 (LI 2015/268).

Regulation 84(3): amended, on 20 December 2015, by regulation 8(3) of the Fisheries (Commercial Fishing) Amendment Regulations 2015 (LI 2015/268).

Regulation 84(3): amended, on 1 October 2014, by regulation 6 of the Fisheries (Commercial Fishing) Amendment Regulations (No 2) 2014 (LI 2014/279).

Regulation 84(3): amended, on 1 October 2009, by regulation 7(2) of the Fisheries (Commercial Fishing) Amendment Regulations (No 2) 2009 (SR 2009/243).

Regulation 84(3): amended, on 1 June 2009, by regulation 11(2) of the Fisheries (Commercial Fishing) Amendment Regulations 2009 (SR 2009/94).

Regulation 84(3): amended, on 1 October 2008, by regulation 6(2) of the Fisheries (Commercial Fishing) Amendment Regulations (No 2) 2008 (SR 2008/272).

Regulation 84(3): amended, on 14 January 2005, by regulation 3 of the Fisheries (Commercial Fishing) Amendment Regulations (No 5) 2004 (SR 2004/443).

Penalties

85 Penalties

- (1) A person who commits an offence against a regulation listed in regulation 84(1) is liable on conviction to a fine not exceeding \$10,000.

- (2) A person who commits an offence against a regulation listed in regulation 84(2) is liable on conviction to a fine not exceeding \$20,000.
- (3) A person is liable on conviction to a fine not exceeding \$100,000 if—
 - (a) that person has been convicted of 2 or more offences against the regulations specified in regulation 84(1) or (2); and
 - (b) the offences were committed on more than 1 occasion within a period of 3 consecutive years.
- (4) Any person who commits an offence against a regulation listed in regulation 84(3) is liable on conviction to a fine not exceeding \$100,000.

Regulation 85(1): amended, on 1 July 2013, by section 413 of the Criminal Procedure Act 2011 (2011 No 81).

Regulation 85(2): amended, on 1 July 2013, by section 413 of the Criminal Procedure Act 2011 (2011 No 81).

Regulation 85(3): amended, on 1 July 2013, by section 413 of the Criminal Procedure Act 2011 (2011 No 81).

Regulation 85(4): amended, on 1 July 2013, by section 413 of the Criminal Procedure Act 2011 (2011 No 81).

Regulation 85(4): amended, on 31 March 2003, by regulation 3 of the Fisheries (Commercial Fishing) Amendment Regulations 2003 (SR 2003/29).

Revocation

86 Revocation

The Fisheries (Commercial Fishing) Regulations 1986 (SR 1986/215) are revoked.

Schedule 1

Diagrams relating to method of measurement of rock lobster

r 39

1 Tail-width measuring device for spiny rock lobster

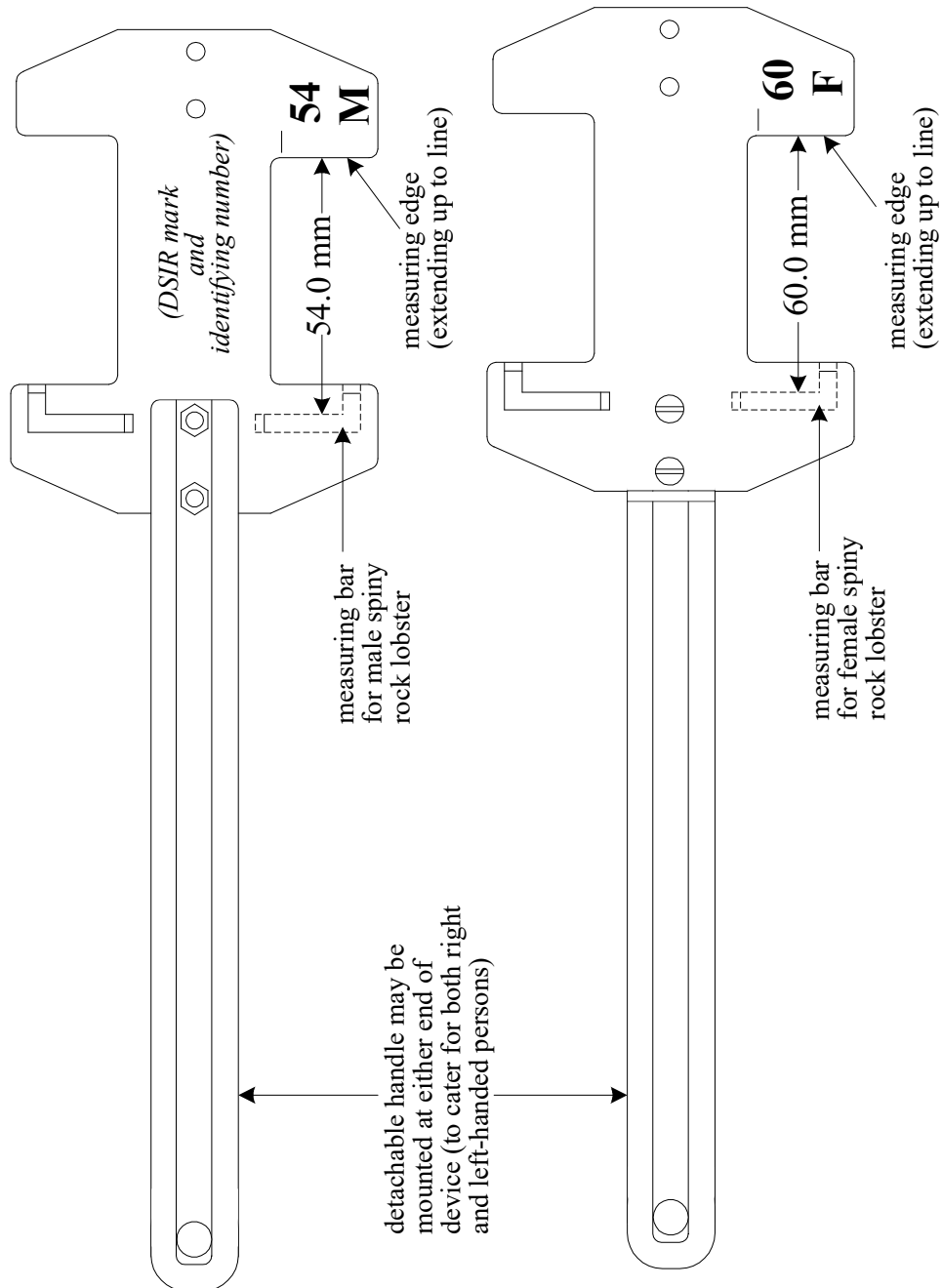

1A Tail-width measuring device for packhorse rock lobster

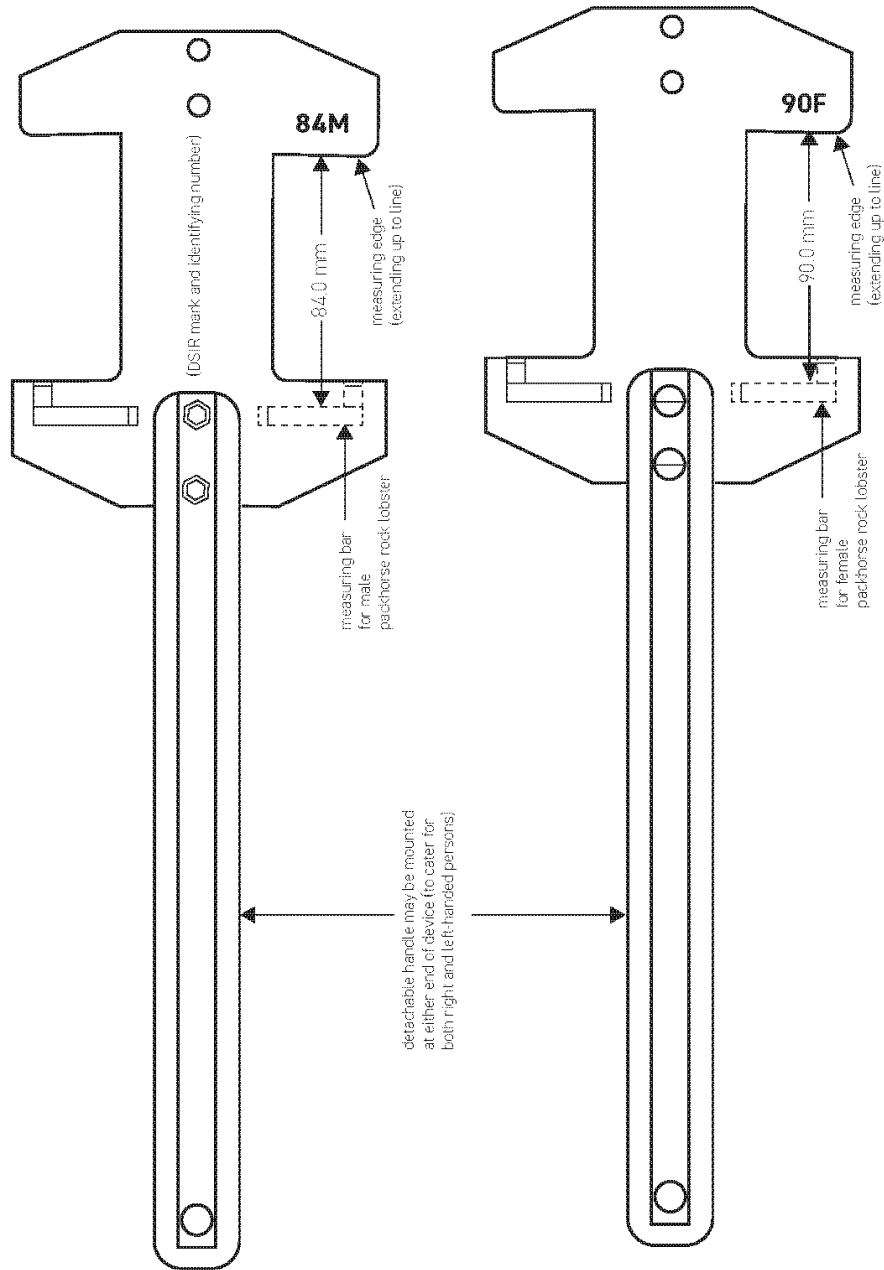

2 Male and female rock lobster

Male (ventral view)

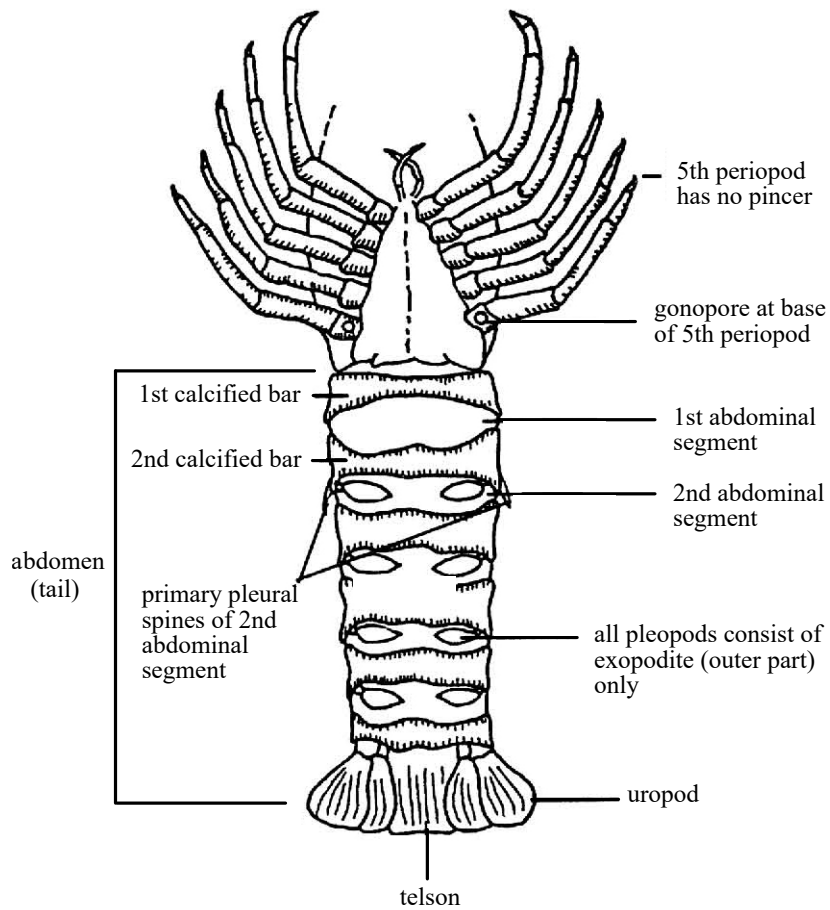

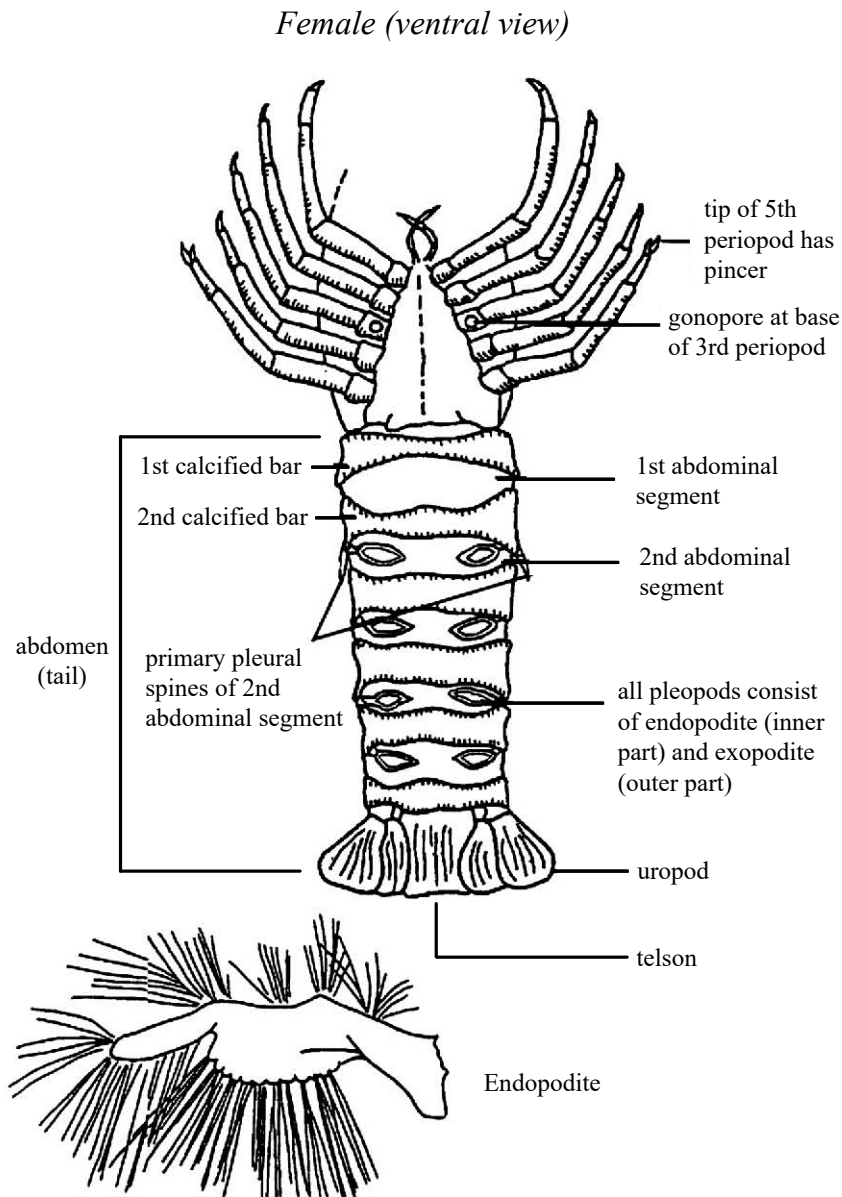

Schedule 1 heading: amended, on 1 April 2024, by regulation 87(1) of the Fisheries Amendment Regulations 2023 (SL 2023/243).

Schedule 1 item 1: amended, on 1 April 2024, by regulation 87(2) of the Fisheries Amendment Regulations 2023 (SL 2023/243).

Schedule 1 item 1A: inserted, on 1 April 2024, by regulation 87(3) of the Fisheries Amendment Regulations 2023 (SL 2023/243).

Schedule 1 item 2: amended, on 1 April 2024, by regulation 87(4) of the Fisheries Amendment Regulations 2023 (SL 2023/243).

Schedule 2 Fees

r 82

Part 1 Preliminary provisions

1 Interpretation

In this schedule, **1983 Act** means the Fisheries Act 1983.

2 Fees GST inclusive

Unless otherwise provided, all fees are inclusive of goods and services tax.

Part 2 Fishing permit fees

3 Application fees for fishing permits

The fees payable in respect of an application for a fishing permit are as follows:

Type of application	\$
(a) for the issue of a permit under section 91 of the Act for a 1-year term	112
(b) for the issue of a permit under section 91 of the Act for a term longer than 1 year (the fee is payable for each whole or part subsequent year for which the permit is issued)	27
(c) for the approval of an agreement under section 89(4)(a) of the Act	36
(d) for the approval of an agreement under section 89(4)(b) of the Act	36
(e) for the approval of a variation of an agreement under section 89(6) of the Act	36
(f) for the issue of a permit under section 93A of the Act	112
(g) for the issue of a duplicate fishing permit	18

Schedule 2 Part 2 clause 3: substituted, on 1 April 2007, by regulation 8(1) of the Fisheries (Commercial Fishing) Amendment Regulations 2007 (SR 2007/32).

4 Application fees for special permits

The fees payable in respect of an application for a special permit under section 97 of the Act are as follows:

Type of application	\$
(a) for the issue of a special permit (for each hour taken to process the application)	133.88 per hour or part hour
(b) for the issue of a duplicate special permit	15
(c) for the amendment or alteration to conditions of a special permit at the request of the permit holder (for each hour taken to process the application)	133.88 per hour or part hour
(d) for the amendment or alteration to conditions of a special permit in another case	15

Schedule 2 Part 2 clause 4(a): amended, on 2 December 2004, by regulation 3(a) of the Fisheries (Commercial Fishing) Amendment Regulations (No 4) 2004 (SR 2004/381).

Schedule 2 Part 2 clause 4(c): amended, on 2 December 2004, by regulation 3(b) of the Fisheries (Commercial Fishing) Amendment Regulations (No 4) 2004 (SR 2004/381).

5 Application fee for section 110(1) approval

	\$
The fee payable in respect of an application for approval by the chief executive under section 110(1) of the Act	190.79

6 Application fee for section 113(1)(a)(ii) approval

	\$
The fee payable in respect of an application for approval by the chief executive under section 113(1)(a)(ii) of the Act	190.79

7 Application fee for section 191(2) approval

	\$
The fee payable in respect of an application for approval by the chief executive under section 191(2) of the Act	18

8 Application fee for section 192(7) approval

	\$
The fee payable in respect of an application for approval by the chief executive under section 192(7) of the Act	18

Part 3

Controlled fisheries fees

[Revoked]

Schedule 2 Part 3: revoked, on 6 October 2023, by regulation 88 of the Fisheries Amendment Regulations 2023 (SL 2023/243).

Application fees

[Revoked]

Heading: revoked, on 6 October 2023, by regulation 88 of the Fisheries Amendment Regulations 2023 (SL 2023/243).

9 Application fees under section 29 of 1983 Act

[Revoked]

Schedule 2 Part 3 clause 9: revoked, on 6 October 2023, by regulation 88 of the Fisheries Amendment Regulations 2023 (SL 2023/243).

Boat authority fees

[Revoked]

Heading: revoked, on 6 October 2023, by regulation 88 of the Fisheries Amendment Regulations 2023 (SL 2023/243).

10 Annual licence fee

[Revoked]

Schedule 2 Part 3 clause 10: revoked, on 6 October 2023, by regulation 88 of the Fisheries Amendment Regulations 2023 (SL 2023/243).

11 No extra fee payable if new boat authority issued for contiguous fishery

[Revoked]

Schedule 2 Part 3 clause 11: revoked, on 6 October 2023, by regulation 88 of the Fisheries Amendment Regulations 2023 (SL 2023/243).

Part 4

Other fees

12 Conversion factor certificates

- | | | |
|-----|--|----|
| | | \$ |
| (1) | The fee payable by the operator of a vessel in respect of which a greenweight conversion factor certificate is given under section 188(2) of the Act | 27 |
| (2) | No fee is payable under this clause if the conversion factor certificate increases the greenweight conversion factor that applies to the vessel | |

§

- (3) The chief executive may waive the fee payable under this clause if the conversion factor certificate is issued for the purpose of making minor amendments to a previous certificate that applies to the vessel

13 Supervision by observers

A fee of \$571.65 (excluding GST) per observer, per day or part of a day, is payable by the vessel operator for the supervision by observers of the following:

- (a) conversion factors
- (b) transshipments. If more than 1 person is liable to pay a fee under this clause in respect of the period during which an observer is on board a vessel, the chief executive may divide the total fee payable between those persons on a proportionate basis, having regard to the percentage of total transshipment hours taken up by each relevant transshipment
- (c) in port unloads
- (d) high-risk and medium-risk foreign-owned New Zealand fishing vessels
- (e) vessels fishing under special permits issued under section 97 of the Fisheries Act 1996
- (f) vessels fishing under high seas fishing permits issued under Part 6A of the Fisheries Act 1996
- (g) vessels in benthic protection areas as defined in the Fisheries (Benthic Protection Areas) Regulations 2007
- (h) vessels where observer supervision has been requested by the owner or operator of a vessel

Schedule 2 Part 4 clause 13: substituted, on 1 June 2009, by regulation 12(1) of the Fisheries (Commercial Fishing) Amendment Regulations 2009 (SR 2009/94).

Schedule 2 Part 4 clause 13(d): replaced, on 1 July 2016, by regulation 4 of the Fisheries (Commercial Fishing) Amendment Regulations 2016 (LI 2016/135).

13A Approval of trawl net

The fee payable in respect of an application for approval under regulation 71A(1), or an application under regulation 71A(4), is \$150.65 per hour or part hour taken to process the application.

Schedule 2 Part 4 clause 13A: inserted, on 1 October 2017, by regulation 8 of the Fisheries (Trawling) Amendment Regulations 2017 (LI 2017/157).

14 Supervision of transshipments

[Revoked]

Schedule 2 Part 4 clause 14: revoked, on 1 June 2009, by regulation 12(1) of the Fisheries (Commercial Fishing) Amendment Regulations 2009 (SR 2009/94).

15 Supervision of dumping at sea

[Revoked]

Schedule 2 Part 4 clause 15: revoked, on 20 December 2015, by regulation 9 of the Fisheries (Commercial Fishing) Amendment Regulations 2015 (LI 2015/268).

16 Automatic location communicators

[Revoked]

Schedule 2 Part 4 clause 16: revoked, on 1 October 2017, by regulation 13 of the Fisheries (Geospatial Position Reporting) Regulations 2017 (LI 2017/155).

17 Marine farming permits and spat catching permits

	\$
(1) The fee payable for an application for a marine farming permit under section 67J of the 1983 Act	2,008.20
(2) The fee payable for an application for a spat catching permit under section 67Q of the 1983 Act	2,008.20
(3) The fee payable for an application by the holder of a marine farming permit or a spat catching permit for a change to the conditions of that permit under section 67K of the 1983 Act	669.40
(4) The fee payable for the notification under section 67M of the 1983 Act of a transfer of an interest in a marine farming permit	133.88

Schedule 2 Part 4 clause 17(1): amended, on 2 December 2004, by regulation 3(c) of the Fisheries (Commercial Fishing) Amendment Regulations (No 4) 2004 (SR 2004/381).

Schedule 2 Part 4 clause 17(2): amended, on 2 December 2004, by regulation 3(c) of the Fisheries (Commercial Fishing) Amendment Regulations (No 4) 2004 (SR 2004/381).

Schedule 2 Part 4 clause 17(3): amended, on 2 December 2004, by regulation 3(d) of the Fisheries (Commercial Fishing) Amendment Regulations (No 4) 2004 (SR 2004/381).

Schedule 2 Part 4 clause 17(4): amended, on 2 December 2004, by regulation 3(e) of the Fisheries (Commercial Fishing) Amendment Regulations (No 4) 2004 (SR 2004/381).

18 Inspection of marine farming register

	\$
(1) The fee payable to inspect the register of marine farming permits that is kept under section 67J(12) of the 1983 Act	133.88
(2) The fee for a photocopy of the register of marine farming permits is 20 cents for each page photocopied	

Schedule 2 Part 4 clause 18(1): amended, on 2 December 2004, by regulation 3(f) of the Fisheries (Commercial Fishing) Amendment Regulations (No 4) 2004 (SR 2004/381).

18A Aquaculture matters

- (1) The fee payable in relation to the following matters is \$2,008.20:

- (a) obtaining and analysing information for the purpose of making an aquaculture decision from the time of receipt of the application for a coastal permit to occupy space in the coastal marine area for an aquaculture activity;
 - (b) an aquaculture decision;
 - (c) preparing for, and making aquaculture decisions in relation to, changes to the conditions of coastal permits (whether the changes are initiated by the holder of the coastal permit or the consent authority that issued it).
- (2) The fee payable in relation to the following matters is \$276 plus \$24.15 for each additional stock involved:
- (a) a decision whether to register a pre-request aquaculture agreement;
 - (b) registering a pre-request aquaculture agreement;
 - (c) a decision whether to register an aquaculture agreement or a compensation declaration;
 - (d) registering an aquaculture agreement or a compensation declaration;
 - (e) any administration associated with registering an aquaculture agreement, a compensation declaration, or a pre-request aquaculture agreement.

Schedule 2 Part 4 clause 18A: inserted, on 1 October 2011, by section 27(1) of the Fisheries Amendment Act 2011 (2011 No 68).

Schedule 2 Part 4 clause 18A(1)(a): amended, on 23 December 2023, by section 6 of the Resource Management (Natural and Built Environment and Spatial Planning Repeal and Interim Fast-track Consenting) Act 2023 (2023 No 68).

Schedule 2 Part 4 clause 18A(1)(b): amended, on 23 December 2023, by section 6 of the Resource Management (Natural and Built Environment and Spatial Planning Repeal and Interim Fast-track Consenting) Act 2023 (2023 No 68).

Schedule 2 Part 4 clause 18A(1)(c): amended, on 23 December 2023, by section 6 of the Resource Management (Natural and Built Environment and Spatial Planning Repeal and Interim Fast-track Consenting) Act 2023 (2023 No 68).

19 Freshwater fish farming licences

[Revoked]

Schedule 2 Part 4 clause 19: revoked, on 2 December 2004, by regulation 3(g) of the Fisheries (Commercial Fishing) Amendment Regulations (No 4) 2004 (SR 2004/381).

20 Remission of fees and additional fees

If the cost of processing an application or a matter (in respect of which a fee is prescribed in clause 17, 18, or 18A(1) of this Part or in the Schedule of the Freshwater Fish Farming Regulations 1983) at the rate of \$133.88 per hour or part of an hour—

- (a) is less than the prescribed fee, the chief executive must remit the balance of the prescribed fee; or
- (b) is more than the prescribed fee, the applicant must pay the additional amount.

Schedule 2 Part 4 clause 20: amended, on 1 October 2011, by section 27(1) of the Fisheries Amendment Act 2011 (2011 No 68).

Schedule 2 Part 4 clause 20: amended, on 2 December 2004, by regulation 3(h) of the Fisheries (Commercial Fishing) Amendment Regulations (No 4) 2004 (SR 2004/381).

Schedule 2 Part 4 clause 20: amended, on 2 December 2004, by regulation 3(i) of the Fisheries (Commercial Fishing) Amendment Regulations (No 4) 2004 (SR 2004/381).

Part 5

Transitional fees

21 Application fee for notified user

	\$
The fee payable for an application made before 1 October 2001 to become a notified user under section 104(1) of the Act	38

22 Application fee to register forward transfer

	\$
The fee payable for an application made before 1 October 2001 to register a forward transfer of annual catch entitlement under section 133(1) of the Act,—	
(a) for the first 10 lines of transfer information	78.75
(b) for a further 10 lines or part of 10 lines	78.75

Schedule 3 Measurement of net mesh size

r 59

Part 1 Diagrams of certified gauges

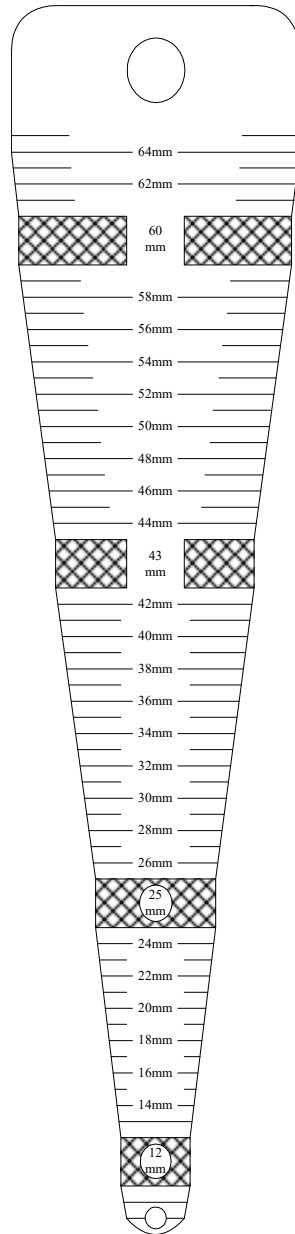

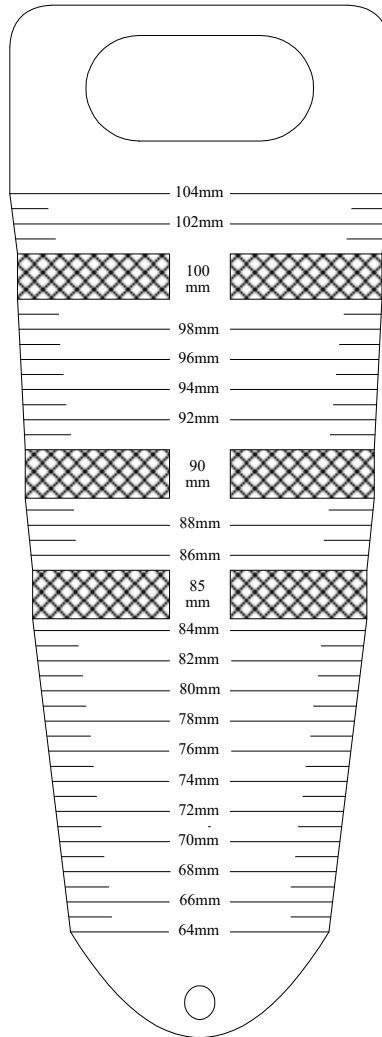

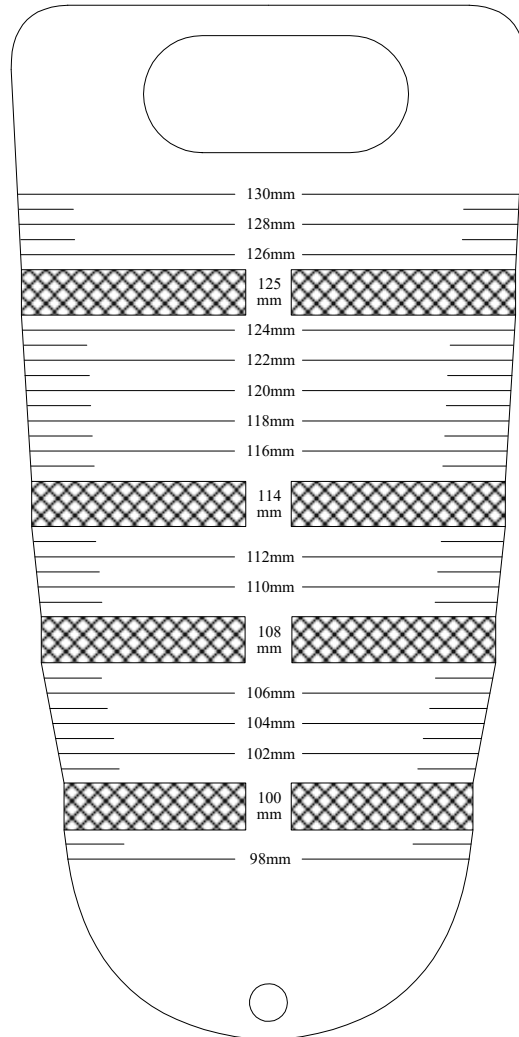

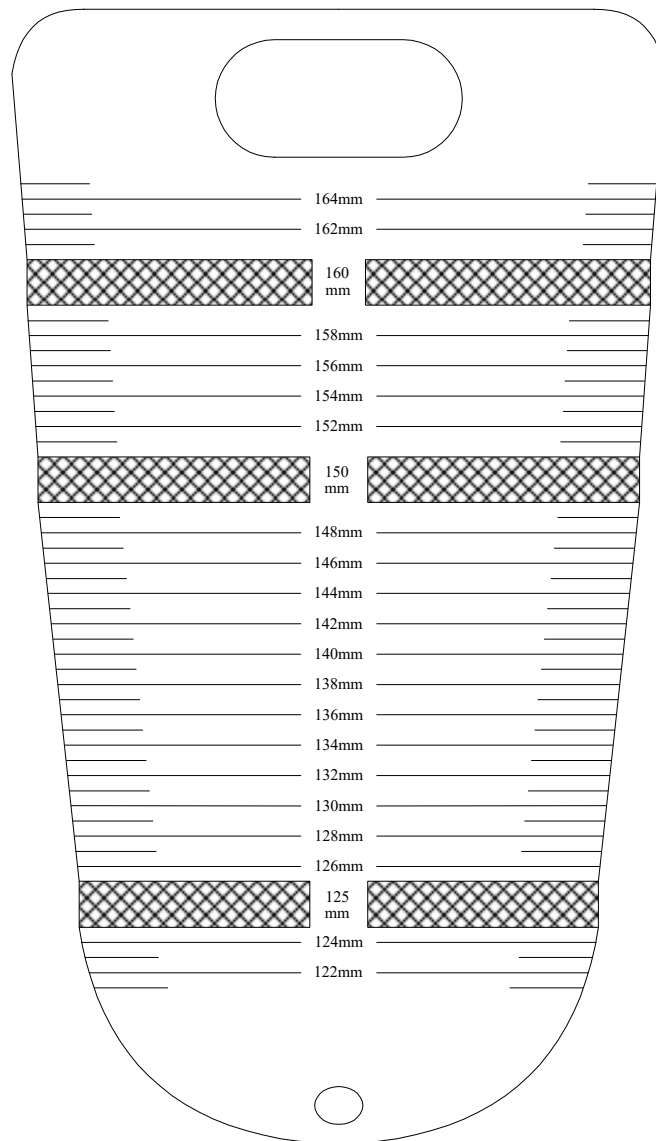

Part 2

Method of net mesh size measurement using certified gauge

Use of certified gauge

- 1 The net must be stretched in the direction of the long diagonal of the meshes.
- 2 A certified gauge must be inserted by its narrowest extremity into the mesh opening at right angles or perpendicular to the plane of the net.

- 3 The gauge must be inserted into the mesh opening, either by manual force or by using a weight described in clause 15 or clause 16, until it is stopped at the tapering edges or parallel edges by the resistance of the mesh.

Selection of meshes to be measured

- 4 Despite clauses 5 and 6, a series of 20 consecutive meshes must be chosen to be measured, in the direction of the longest dimension of the net.
- 5 Mesh that has been mended or broken or has attachments fixed to the net must not be included for measurement.
- 6 The meshes to be measured under clause 4 need not be consecutive if the application of clause 5 prevents it.

Measurement of each mesh

- 7 Each mesh must be the width of the gauge at the point where the gauge is stopped, in accordance with clauses 1 to 3.

Determination of the mesh size of net

- 8 The mesh size of the net is the arithmetical mean in millimetres of the measurements of the total number of meshes selected and measured, as provided for in clauses 4 to 7 (the arithmetical mean being rounded up to the next millimetre).
- 9 The total number of meshes to be measured is provided for in clauses 10 to 13.

Sequence of measuring procedure

- 10 A fishery officer must measure a series of 20 meshes, selected in accordance with clauses 4 to 6, by inserting the gauge manually without using a weight.
- 11 The mesh size of the net must be determined in accordance with clause 8.
- 12 If the calculation of the mesh size shows that the mesh size does not appear to comply with the requirements of these regulations, then 2 additional series of 20 meshes selected in accordance with clauses 4 to 6 must be measured.
- 13 The mesh size must be recalculated in accordance with clause 8, taking into account the 60 meshes already measured.
- 14 Subject to clauses 15 to 18, this is the mesh size of the net.

Procedure to be used when measurement contested

- 15 If the operator of the vessel or any other person contests a determination of mesh size made in accordance with clauses 10 and 11, the net must be remeasured by using the appropriate weight specified in clause 16 or clause 17 and by

- measuring a series of 20 meshes that have not previously been measured. This will be the net mesh size when calculated in accordance with clause 8.
- 16 For remeasurement, a weight must be attached to the gauge, affixed to the hole in the narrowest extremity of the gauge by means of a hook.
- 17 For nets with a mesh size of 35 mm or less, as determined in accordance with clauses 10 and 11, and for all beach seine nets, drag nets, and set nets, a force of between 19.59 N and 19.63 N (equivalent to a mass of 2 kg) must be applied by using a weight of 2 kg.
- 18 For nets with a mesh size of more than 35 mm, as determined in accordance with clauses 10 and 11, a force of between 48.97 N and 49.07 N (equivalent to a mass of 5 kg) must be applied by using a weight of 5 kg.
- 19 A weight must not be used for the purposes of this schedule unless it—
- (a) bears an identifying mark including the letters “MAF”, and a number referred to in a report referred to in paragraph (b); and
 - (b) is certified by reference to the mark and number referred to in a report issued either by the Measurements Standards Laboratory of New Zealand (as defined in the National Standards Regulations 1976) or by an inspector or an accredited person (as those terms are defined in section 2 of the Weights and Measures Act 1987) as being accurate for the purposes of these regulations.

Schedule 4
**Provisions relating to marking of New Zealand fishing vessels and
foreign-owned New Zealand fishing vessels**

rr 10, 11, 13

1 Lettering

Block lettering and figures must be used.

2 Height

The height of the letters and figures must be in proportion to the size of the vessel.

3 Marks

The height of letters and figures placed on the hull, superstructure, or inclined surfaces must be as specified in the following table:

Overall length of vessels (m)	Minimum height of letters and numbers (m)
28 or over	1.0
20 or over but less than 28	0.8
15 or over but less than 20	0.6
12 or over but less than 15	0.4
5 or over but less than 12	0.3
Less than 5	0.1

4 Hyphen length

The length of the hyphen must be half the height of the letters and figures.

5 Stroke width

The width of the stroke for all letters and the hyphen must be one-sixth of their height.

6 Spaces between letters and numbers

The space between letters and between figures and between letters and figures must not exceed a quarter of their height nor be less than one-sixth of their height.

7 Spaces between adjacent letters with sloping sides

The space between adjacent letters that have sloping sides must not be more than one-eighth of their height nor less than one-tenth of their height.

Schedule 5
Authorised stocks

[Revoked]

r 81

Schedule 5: revoked, on 1 October 2004, by section 65(1) of the Fisheries Amendment Act (No 3) 2004 (2004 No 76).

Martin Bell,
Acting for Clerk of the Executive Council.

Issued under the authority of the Legislation Act 2019.
Date of notification in *Gazette*: 20 September 2001.

Notes

1 *General*

This is a consolidation of the Fisheries (Commercial Fishing) Regulations 2001 that incorporates the amendments made to the legislation so that it shows the law as at its stated date.

2 *Legal status*

A consolidation is taken to correctly state, as at its stated date, the law enacted or made by the legislation consolidated and by the amendments. This presumption applies unless the contrary is shown.

Section 78 of the Legislation Act 2019 provides that this consolidation, published as an electronic version, is an official version. A printed version of legislation that is produced directly from this official electronic version is also an official version.

3 *Editorial and format changes*

The Parliamentary Counsel Office makes editorial and format changes to consolidations using the powers under subpart 2 of Part 3 of the Legislation Act 2019. See also PCO editorial conventions for consolidations.

4 *Amendments incorporated in this consolidation*

Resource Management (Natural and Built Environment and Spatial Planning Repeal and Interim Fast-track Consenting) Act 2023 (2023 No 68): section 6

Fisheries Amendment Regulations 2023 (SL 2023/243): Part 5

Fisheries (Commercial Fishing) Amendment Regulations (No 2) 2023 (SL 2023/242): Part 1

Fisheries (Commercial Fishing) Amendment Regulations 2023 (SL 2023/171)

Fisheries (Hector's and Māui Dolphin) Amendment Regulations 2022 (SL 2022/314): Part 2

Commercial Fishing (Sea Lion Exclusion Device) Amendment Regulations 2021 (SL 2021/398)

Legislation Act (Sub-delegated Secondary Legislation) Regulations 2021 (LI 2021/248): regulations 28–32

Fisheries (Hector's and Māui Dolphin) Amendment Regulations 2020 (LI 2020/199): Part 5

Fisheries (Commercial Fishing) Amendment Regulations 2020 (LI 2020/85)

Fisheries (Co-ordinates) Amendment Regulations 2019 (LI 2019/292): regulation 4

Fisheries (Commercial Fishing) Amendment Regulations 2018 (LI 2018/261)

Fisheries (Trawling) Amendment Regulations 2017 (LI 2017/157): Part 1

Fisheries (Geospatial Position Reporting) Regulations 2017 (LI 2017/155): regulation 13

Fisheries (Reporting) Regulations 2017 (LI 2017/154): regulation 51

Fisheries (Commercial Fishing) Amendment Regulations 2016 (LI 2016/135)

Fisheries (Commercial Fishing) Amendment Regulations 2015 (LI 2015/268)

Fisheries (Commercial Fishing) Amendment Regulations (No 2) 2014 (LI 2014/279)

Fisheries (Commercial Fishing) Amendment Regulations 2014 (LI 2014/17)

Fisheries (Commercial Fishing) Amendment Regulations 2013 (SR 2013/325)
Criminal Procedure Act 2011 (2011 No 81): section 413
Fisheries Amendment Act 2011 (2011 No 68): section 27(1)
Fisheries Regulations Revocation Order 2011 (SR 2011/96): clause 3
Fisheries (Commercial Fishing) Amendment Regulations (No 2) 2009 (SR 2009/243)
Fisheries (Commercial Fishing) Amendment Regulations 2009 (SR 2009/94)
Fisheries (Commercial Fishing) Amendment Regulations (No 2) 2008 (SR 2008/272)
Fisheries (Commercial Fishing) Amendment Regulations 2008 (SR 2008/26)
Fisheries (Commercial Fishing) Amendment Regulations (No 2) 2007 (SR 2007/252)
Fisheries (Commercial Fishing) Amendment Regulations 2007 (SR 2007/32)
Fisheries (Commercial Fishing) Amendment Regulations (No 2) 2006 (SR 2006/235)
Fisheries (Commercial Fishing) Amendment Regulations (No 5) 2004 (SR 2004/443)
Maritime Transport Amendment Act 2004 (2004 No 98): section 11(4)
Fisheries (Commercial Fishing) Amendment Regulations (No 4) 2004 (SR 2004/381)
Fisheries (Commercial Fishing) Amendment Regulations (No 3) 2004 (SR 2004/329)
Fisheries Amendment Act (No 3) 2004 (2004 No 76): section 65(1)
Fisheries (Commercial Fishing) Amendment Regulations (No 2) 2004 (SR 2004/284)
Fisheries (Commercial Fishing) Amendment Regulations (No 2) 2003 (SR 2003/222)
Fisheries (Commercial Fishing) Amendment Regulations 2003 (SR 2003/29)
Fisheries (Commercial Fishing) Amendment Regulations 2002 (SR 2002/157)